

PM-2000

OPERATING MANUAL



YAMAHA

INTRODUCTION	1
INPUT MODULE	3
MASTER MODULE	4
FOLDBACK/PHONE MODULE	5
EFFECTS MODULE	5
TALKBACK MODULE	6
MIX MATRIX	7
REAR PANEL	8
POWER SUPPLY	9
METER PANEL	9
SPECIFICATIONS	10
GENERAL	10
INPUT CHARACTERISTICS	12
OUTPUT CHARACTERISTICS	12
INSTALLATION	13
POWER MAINS	13
THEORY OF GROUNDING	13
INTERCONNECTIONS	14
PADS, TRANSFORMERS & DIRECT BOXES	15
DYNAMIC RANGE	19
OPERATING LEVELS	20
GAIN OVERLAP & HEADROOM	21
CALCULATING & USING GAIN OVERLAP	21
INTERFACE WITH CREATIVE AUDIO EQUIPMENT	22
ADDING AN ADDITIONAL 10dB OF GAIN TO THE PM-2000 OUTPUT STAGES	22
APPENDIX	23
MAINTENANCE	23
TRAVEL CASE	25
APPLICATIONS	26
CONCERT SOUND REINFORCEMENT	26
STAGE MONITORING	30
TELEVISION SHOW PRODUCTION	32
TELEVISION REMOTE PRODUCTION	34
THEATRICAL PRODUCTION	36
RECORDING & MIXDOWN	38
BLOCK DIAGRAM	40

INTRODUCTION

PM-2000 MIXING CONSOLE

In 1974 Yamaha set new standards of excellence for sound reinforcement with the introduction of our first PM-1000 mixing console. Since then, PM-1000's have been used by virtually every major sound company, and praised by top artists around the world. PM-1000 consoles enjoy a well-earned reputation for reliably delivering the sound and mixing flexibility necessary in today's creative performances.

We were pleased by the success of our PM-1000, but viewed it only as a beginning. The need for an even more sophisticated Yamaha console became apparent, so for the last 5 years we surveyed the professional sound community in depth, learning which features are considered most important. At the same time, new circuits were devised, circuits capable of even better performance than the already-respectable PM-1000. Every detail, including panel layout and cabinetry, received careful scrutiny. The goal was nothing less than a total mixing system, one suitable for concert sound reinforcement, theatrical or broadcast production, and recording — it would become known as the PM-2000 mixing console.

We subjected the PM-2000 to an extended program of rigorous laboratory and field testing, calling upon top experts in every facet of the U.S. audio industry to evaluate prototypes and work out improved designs. When prototype consoles satisfied the most stringent criteria on the lab bench and in studio evaluations, we sent them out on numerous national and international tours for "hands-on" evaluation. Here PM-2000's received a two year shake-down, the most valid of field tests. Yamaha's stress on "real world" research and development was an expensive but worthwhile investment that had a major impact on the new console's character. It was a very special kind of R&D which relied upon close communication with the touring soundmen and engineers. We took the opportunity to discover any latent difficulties ("if only they'd have . . .") in time to avoid them. You showed us what was needed. We supplied the intense research and the in-depth resources to make it happen — the Yamaha PM-2000!

When you sit down to mix on a PM-2000 it commands your respect. Yet for all its complexity and sophistication, you'll find the console's layout uncluttered and its functions self-explanatory; mixing with a PM-2000 comes naturally. The PM-2000 somehow imparts immediate confidence to any operator, and comfortable familiarity to anyone who already knows the PM-1000. Controls are well marked, sensibly organized, and perfectly damped to respond to your most subtle touch.

Before long, you become aware of a very special feeling. It is a feeling of elegance, of authority, of control. As your eyes scan this impressive mixing console, you see banks of large VU meters glowing clearly above anti-glare black panels that are punctuated by color-coded knobs, illuminated channel-ON switches, and the occasional red flash of an input's LED peak indicator. Every so often an LED lights up in an otherwise tame output VU meter, warning that the instantaneous level is approaching a clip, but with +24dBm output capability the console is seldom driven to its maximum. You wonder what it is about the PM-2000 that gives you a rush of enthusiasm. Could it be the rich rosewood housing? Or is it simply that everything you need is at your fingertips, beckoning to your creative instincts? Whatever the reason, you understand why this console is in a class by itself.

No, you are not beguiled. The PM-2000 is the ultimate tool for creative audio mixing. Whether you choose the compact 24 input mainframe, or the 32 input version, you get 14 mixing buses, 4-knob 20-frequency equalizers, switchable pre/post take-off for effects and monitor sends, interstage patching, headphone cue and talkback systems, a combination oscillator/pink noise source, and more. Much more, in fact, because each of these features is extraordinary by itself.

Take the equalizer, for example. Four knobs each provide 15dB of boost or cut at 5 frequencies, a total of 20 frequencies in overlapping ranges. The LOW and HIGH EQ ranges have shelving curves for broad tonal corrections, while the LOW-MID and HIGH-MID ranges offer peaking characteristics for more exacting manipulation of the program. The controls are center-detented so it's easy to return to a "flat" setting, and are center-tapped so "flat" is absolutely flat. Of course, an EQ IN/OUT switch facilitates A-B comparisons or fast changes in tonal balance. The equalizer is an active design with precision R-C networks and operational amplifiers. We also provide a separate 18dB/octave High Pass Filter with 40Hz and 80Hz positions, so you don't have to use the equalizer to eliminate unused low frequencies or avoid problem sounds like wind noise, stage rumble, dropped mics, vocal P-pops, etc.

Of the 14 mixing buses, 8 are designated for main program mixing, 4 for foldback (stage monitoring), and 2 for echo/effects sends. Each bus has its own master control, making it easy to pre-mix different "scenes," to instantly move from one type of mix to another, or to quickly re-balance sub-groups of instruments, vocals and effects. In addition to all this, the PM-2000 has a unique mix matrix.

The matrix allows the 14 mixing buses, plus auxiliary inputs, to be combined into 8 discrete mixes. Each of the 8 matrix mixes has its own master control, channel ON/OFF switch, and appears at a direct console output. You can use the main program outputs to make a "dry" tape recording, while feeding the sound reinforcement system with the matrix output; any desired effects can be introduced to the matrix via its auxiliary inputs. The matrix can save a tremendous amount of time and effort when you want to set up individual stage monitor mixes, feed different speaker mixes to various zones of the house, feed local and remote programs simultaneously, monitor in stereo during multi-channel recording, etc. — all this, with no need for special patching or outboard submixers.

The PM-2000 is built with only the finest components, including low-noise mic preamps and accurate faders. Electronically, all circuitry is designed for low noise, low distortion and maximum stability; residual output noise is below -90dBm, and even at full +24dBm output level, the IM and harmonic distortion remain unmeasurable on all but the most sensitive equipment. Unwanted hum (and heat) are excluded by using a remote power supply, linked to the PM-2000 by a detachable "umbilical cord." Not only is the console quiet internally, it also rejects external noise. Balanced or floating inputs and outputs block common-mode noise, while extensive shielding and bypassing provide immunity to RFI (radio frequency interference).

That the PM-2000 is a genuine value, a shining example of modern electronic and mechanical design, is no accident. It is the direct result of Yamaha's experience in building thousands of professional mixers and consoles, as well as power amplifiers, electronic crossovers, speaker systems, etc. The PM-2000 is perhaps even more of a

value due to Yamaha's diverse, worldwide manufacturing resources: lumber mills (for wood cabinetry), foundries (for metal parts), and semiconductor factories (for transistors and IC chips). Because the unit is one of the most reliable products on the market, is a state-of-the-art design, and is backed by Yamaha, the PM-2000 will retain its value for years. Thus, when you buy a PM-2000, you are making a good investment — in terms of resale value, day-to-day performance, and the satisfaction that comes from owning the ultimate mixing console.

INPUT MODULE

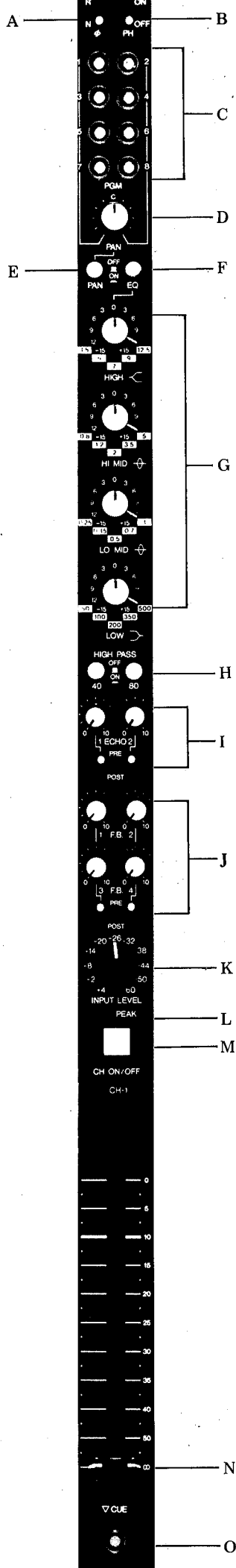

- A. PHASE switch inverts the polarity of the audio signal entering the input module, eliminating the need for adapters or connector rewiring.
- B. PHANTOM POWER switch applies 48V DC across the channel input connector's balanced signal leads and the cable shield: for remote powering of condenser microphones.
- C. PROGRAM ASSIGN pushbuttons apply the channel output to any combination of the 8 main mixing busses; a bright color shows when the button is engaged.
- D. PAN POT adjusts the relative output level between all odd-numbered and even-numbered program mixing busses which have their Program Assign buttons engaged.
- E. PAN ON/OFF pushbutton actuates the Pan Pot function.
- F. EQ ON/OFF pushbutton bypasses or inserts the channel equalizer for rapid changes between "flat" and "EQ'd" sound.
- G. EQUALIZER has 4-knobs that each provides 15dB of boost or cut, with center detent at "flat" (no EQ) position. A concentric lever switch on each knob selects the frequency band affected, as indicated below:
 - LOW range = 50, 100, 200, 350 or 500Hz (Shelving)
 - LOW-MID range = 250, 350, 500, 700 or 1,000Hz (Peaking)
 - HIGH-MID range = 0.8, 1.2, 2, 3.5 or 5kHz (Peaking)
 - HIGH range = 3.5, 5, 7, 9 or 12.5kHz (Shelving)
- H. HIGH PASS FILTER pushbuttons allow for flat response when OFF, but may be switched to cut frequencies below 40Hz or 80Hz at the rate of 18dB/octave, a sharper cutoff than the EQ. The filter is useful for avoiding unwanted rumble and pops, protecting speakers, etc.
- I. ECHO knobs provide for two separate echo, effects, or monitor mixes. Adjacent PRE/POST switches determine whether the pick-off comes before or after the channel Fader (the PRE-Fader pick-off is factory wired to come after the EQ, but can be moved ahead of the EQ by restrapping a jumper within the module).
- J. FOLDBACK knobs provide for four separate foldback, monitor or effects mixes. PRE/POST switches adjacent to each pair of knobs determine whether the pick-off comes before or after the channel EQ and Fader (the PRE-EQ & Fader pick-off may be changed to come after the EQ by restrapping a jumper within the module).
- K. INPUT LEVEL switch determines the nominal channel sensitivity. By varying the preamplifier gain and/or attenuating the incoming signal, this switch preserves maximum headroom and minimum noise at each of 11 settings: -60, -50, -44, -38, -32, -26, -20, -14, -8, -2 and +4dB (Re: 0.775V).
- L. PEAK indicator LED turns ON whenever the post-EQ, pre-Fader signal level reaches 3dB below clipping. This permits the Input Level switch to be quickly adjusted for the highest sensitivity that still preserves full headroom. With levels properly set, the LED does not normally flash, but it will warn the operator if too much equalizer boost is applied or if the program level becomes excessive.
- M. CHANNEL ON/OFF pushbutton removes the incoming program from all channel outputs when OFF. This is particularly handy for rapid punch-ins, and punch-outs, or for temporarily killing a channel without disturbing any of its mix levels. The button is illuminated to let the operator know the channel is ON.
- N. FADER travel is smooth and provides dB-calibrated attenuation. Integral seals in the slider keep out dust and dirt.
- O. CUE pushbutton assigns the post-EQ, pre-Fader signal to the cue bus and triggers a relay in the Foldback/Phone module. The relay substitutes the cue bus for any other busses assigned to the headphone jacks so the channel(s) can be previewed prior to raising the Fader, Echo or Foldback controls. CUE also is useful for identifying inputs, troubleshooting "bad" mics, etc. Individual channel CUE buttons may be momentarily depressed or latched ON, displaying a bright color when engaged; a "reminder" Cue LED in the FB/Phone module also turns ON whenever a Cue button is engaged.

NOTE: Inside this module are located a mic preamp, filter and EQ circuits, booster and line amplifiers, and jumpers for pre-post EQ selection of echo and foldback mixing busses.

MASTER MODULE

MIX MATRIX SECTION*

- A. ECHO 1 & 2 controls pick off the signal from the two echo send output busses (after the Echo Send Master), assigning them to this one channel of the Mix Matrix.
- B. FOLDBACK 1, 2, 3 & 4 controls pick off the signal from the four foldback output busses (after the Foldback Master controls), assigning them to this one channel of the Mix Matrix.
- C. PROGRAM 1, 2, 3, 4, 5, 6, 7 & 8 controls pick off the signal from the eight program output busses (after the Master Faders), assigning them to this one channel of the Mix Matrix.
- D. MATRIX MASTER control adjusts the overall mix level of any Echo, Foldback and Program signals assigned to this one channel of the Mix Matrix, and hence sets the level of the matrix output.
- E. MATRIX ON/OFF pushbutton determines whether this channel of the Mix Matrix is available to the headphone mix and the rear-panel matrix output connector. This is particularly handy for rapid punch-ins, and punch-outs, or for temporarily killing a matrix output without disturbing any of its mix level settings. The button is illuminated to let the operator know when the Mix Matrix channel is ON.
- F. AUX IN control adjusts the signal level applied to this one channel of the Mix Matrix from the correspondingly numbered Auxiliary Input. May be used to introduce effects into the Mix Matrix while keeping the program outputs "dry."

MASTER OUTPUT SECTION

- G. MASTER ON/OFF pushbutton turns the correspondingly numbered program output ON or OFF. This is particularly handy for rapid punch-ins, and punch-outs, or for temporarily killing an output without disturbing the Master Mix level. The button is illuminated to let the operator know when the output channel is ON.
- H. MASTER FADER has smooth, dB-calibrated action, integral dust seals. Each Master Fader sets the level of the correspondingly numbered program output bus.
- I. CUE pushbutton assigns the pre-Master Fader signal to the cue bus and triggers a relay in the Foldback/Phone module. The relay replaces whatever program had been assigned to the headphone jacks with the cue bus signal, enabling the program mix channel to be previewed without raising a Master Fader (no signal need be fed to the program output). The CUE function also is useful for identifying mix busses, troubleshooting, etc. Individual Master CUE buttons may be momentarily depressed or latched ON, displaying a bright color when engaged; whenever CUE is engaged, an LED "reminder" in the FB/Phone module turns ON.

NOTE: Inside this module are located the Aux Input transformer and line amplifier, the Program Output sum, booster and line amplifiers, and the Matrix Output line amplifier.

**There are a total of 8 Mix Matrix channels located in, and numbered to correspond with, each of the 8 Master Modules.*

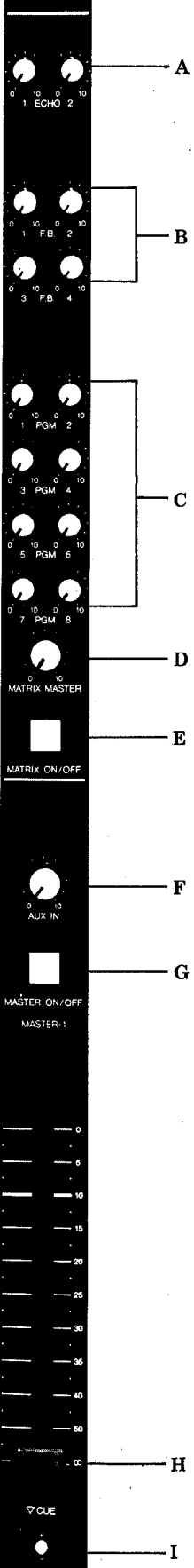

FOLDBACK/PHONE MODULE

EFFECTS MODULE

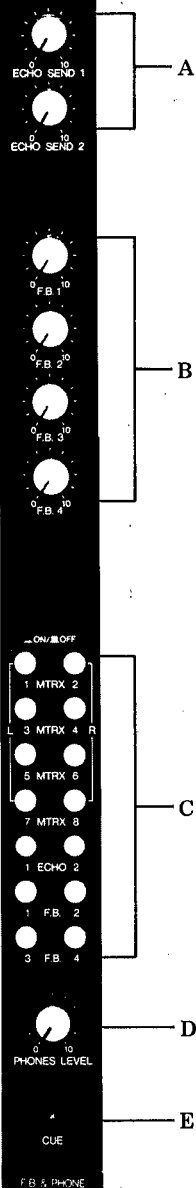

- A. ECHO SEND 1 & 2 Master controls adjust the overall echo output bus levels.
- B. FOLDBACK 1, 2, 3 & 4 Master controls adjust the overall foldback output bus levels.
- C. HEADPHONE ASSIGN pushbuttons select those signals mixed into the headphone outputs: Mix Matrix outputs 1 through 8, Echo Send outputs 1 and 2, and/or Foldback outputs 1 through 4. Odd-numbered matrix outputs feed the Left muff and even-numbered busses feed the Right muff of any stereo headphones plugged into either of the two headphone jacks. Echo and Foldback outputs feed both sides of the headphone output; these, and any Mix Matrix Left and Right phones signals are summed (mono) for the rear-panel phones output XLR connector.
- D. PHONES LEVEL control adjusts the overall signal level fed to both stereo headphone jacks, and to the mono phones connector.
- E. CUE indicator LED turns ON whenever a Cue button is engaged on any Input Module or Master Module. This reminds the operator that the headphones are carrying the cue bus signal, not the program selected with the Headphone Assign pushbuttons (above).

NOTE: Inside this module are located summing and line amplifiers for the foldback, echo and cue busses, as well as the cue relay.

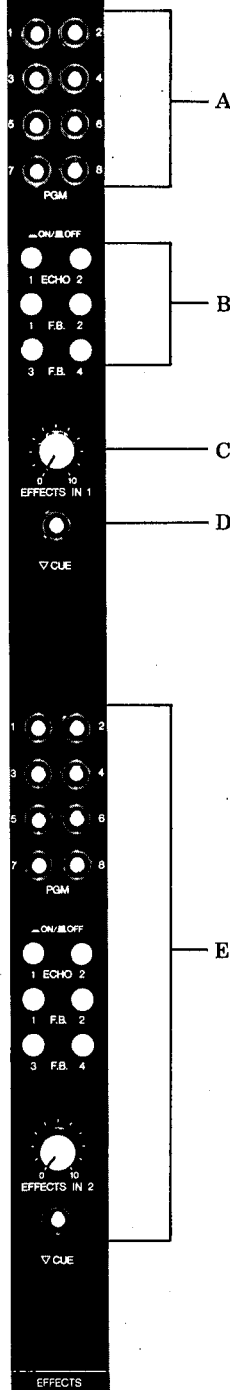

The following two clusters of controls may be used for processing an echo or reverb return, as an assignable auxiliary bus input, and so forth.

EFFECTS IN #1 SECTION

- A. PROGRAM ASSIGN pushbuttons apply the EFFECTS INPUT #1 signal to any combination of the 8 main mixing busses; a bright color shows when a button is engaged.
- B. ECHO & FOLDBACK ASSIGN pushbuttons apply the EFFECTS IN #1 signal to any combination of the 2 echo and 4 foldback mixing busses.
- C. EFFECTS IN #1 Level control adjusts the level of the incoming signal to be applied to the mix busses.
- D. EFFECTS INPUT CUE pushbutton assigns the #1 Effects Input signal (derived after the level control) to the cue bus and simultaneously triggers a relay in the Foldback/Phone module. The relay substitutes the cue bus for any other busses assigned to the headphone jacks. The Effects In signal thus can be previewed prior to switch-assigning it to the various program, echo or foldback busses. This CUE function also is useful for listening to only the effects portion of the program during a mixing session. The CUE button may be momentarily depressed or latched ON, displaying a bright color when engaged; a "reminder" Cue LED in the FB/Phone module also turns ON whenever a CUE button is engaged.

EFFECTS IN #2 SECTION

- E. This cluster of controls is identical to the above, but processes the signal from EFFECTS INPUT #2.

NOTE: Inside this module are located attenuation pads, transformers, and booster amplifiers for the two effects input sections.

TALKBACK MODULE

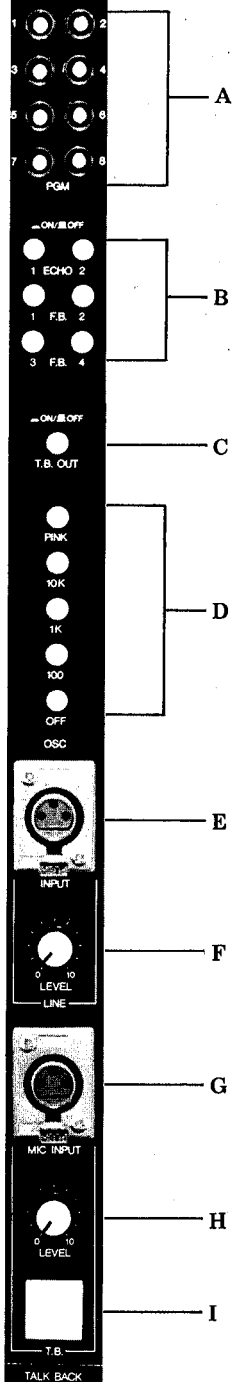

- A. PROGRAM ASSIGN pushbuttons apply the Talkback or Oscillator/Noise Generator signal to any combination of the 8 main mixing busses; a bright color shows when an Assign button is engaged.
- B. ECHO & FOLDBACK ASSIGN pushbuttons apply the Talkback or Oscillator/Noise Generator signal to any combination of the 2 echo and 4 foldback mixing busses.
- C. TB OUTPUT ON/OFF pushbutton applies signal to the rear-panel XLR Talkback output connector, the Talkback VU meter and the LED peak indicator. Note that when the TB OUTPUT switch is OFF, the module's output can still be assigned to the program, echo and foldback busses, even though the Talkback metering is inactive.
- D. OSCILLATOR/NOISE GENERATOR pushbuttons offer a choice of sinewave signal at 100Hz, 1kHz, or 10kHz, as well as pink noise. The Oscillator/Noise Generator may be assigned to the busses as well as to a direct output, and is handy for signal tracing, tape machine alignment, sound system setup, troubleshooting, and similar purposes. The Oscillator/Noise Generator should be switched OFF when it is not in use.
- E. LINE INPUT connector, a female XLR-3, accepts nominal -20dB (Re: 0.775V) inputs for assignment to the program, echo and/or foldback busses. This connector may be used for interface with popular 3-wire intercom systems, or for introducing "background" or "intermission" music to the mix busses; the LINE INPUT will be applied to any bus whose TB Assign pushbutton is engaged. The Line In signal only appears at the Talkback output when the TB ON/OFF switch is ON.
- F. LINE INPUT LEVEL control attenuates the level of signals applied to the Line Input (decrease the setting of this control and TB LINE IN accepts $+4\text{dB}$ nominal levels).
- G. MIC INPUT connector, a female XLR-3, accepts nominal -50dB (Re: 0.775V) inputs. This input is balanced and is ideal for interface with most low impedance (50 to 250 ohm) dynamic, ribbon or self-powered electret condenser microphones. The input is activated by engaging the TB pushbutton; it is assigned to any of the program, echo or foldback mixing busses selected with the module's Assign pushbuttons, and/or to the direct Talkback output. This input is useful for communication with technicians, work crews and performers during system setup, for announcements, for control room-to-studio communication, and for voice ID ("slating") of tape recordings.
- H. MIC INPUT LEVEL control adjusts the amplification of the Mic Input (may be adjusted up to -70dB sensitivity to accommodate lower level microphone signals).
- I. TALKBACK (TB) pushbutton, when engaged, activates the TB Mic Input. When the TB button is not engaged, the Oscillator/Noise Generator will feed any busses to which the module is assigned (unless of course the Oscillator/Noise Generator is switched OFF). The TB button has no effect on the Line Input; both Mic and Line sources may be assigned simultaneously.

NOTE: Inside this module are located mic and line input transformers, a mic preamplifier, booster amplifiers, the oscillator and noise generating circuits, and a line amplifier.

MIX MATRIX

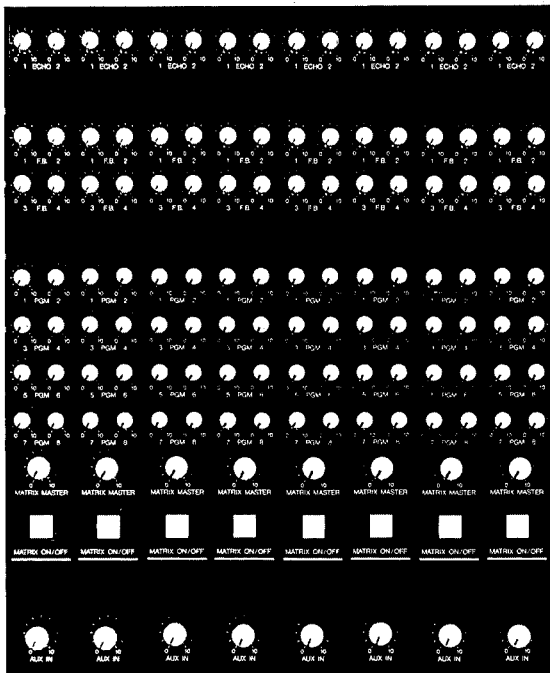

The Mix Matrix is located on the upper sections of the 8 Master Modules. Each Master Module houses one channel of the matrix, and can be used to create a discrete mono combination from the console's 14 mixing busses. Each of the 8 matrix channels has the following controls (discussed in greater detail in the Master Module Description).

- ECHO 1 & 2 level
- FOLDBACK 1 — 4 level
- PROGRAM 1 — 8 level
- MATRIX MASTER level
- MATRIX ON/OFF switch
- AUX IN level

The 2 Echo, 4 Foldback and 8 Program inputs to each matrix channel are all derived *after* their respective bus Master Faders. The 8 matrix channel outputs are available directly at rear panel XLR connectors.

NOTE: When reading these matrix application descriptions, refer also to the sound system diagrams which follow and to the fold-out console block diagram.

FOR SOUND REINFORCEMENT

The program, echo and foldback busses may be used for sub-grouping of different sources; i.e., brass, drums/percussion, vocal backup, lead vocal, etc. The Mix Matrix outputs are then used to feed power amps (& speakers) for various zones in the main house, the stage, and other areas. With all Master Faders at nominal settings, a basic balance of the sub-groups can be established independently for each zone of the sound system by using its matrix channel.

There are a number of advantages to this approach. For instance, if the brass level is too high in all outputs, only one Master Fader need be adjusted, and the balance will simultaneously change in all matrix outputs. For program fades, all Matrix Masters may be brought down; the previously established balance for each zone of the sound system reappears as soon as the Masters are again brought back to nominal settings. Also, if any recordings are being made directly from the program outputs their fades need not follow the house fades because the Matrix Master controls do not affect the recording levels.

The PM-2000's foldback and echo busses may be used for stage monitoring when a separate monitor mixer is not available. For more elaborate stage monitoring and simultaneous house mixing, the PM-2000's program outputs can feed the house sound system, and the Mix Matrix can create 8 different stage monitor mixes.

FOR STAGE MONITORING

In a stage monitor console it is generally desirable to obtain many different output mixes. With the PM-2000 one could use the 4 foldback outputs for 4 monitor mixes. The 8 program busses could be assigned as sub-groups and then combined on the Mix Matrix to achieve 8 additional monitor mixes. The echo send outputs may be used for actual reverberation and return, especially if the vocalist(s) enjoy some reverb in the monitors; if not these outputs provide additional monitor mixes. At the same time, the sub-grouped pro-

gram outputs can be fed to the main mixing console for incorporation in the house mix.

FOR RECORDING

When a multi-track tape recording is being made, the 8 program bus outputs can feed the recorder directly; simultaneously, any two of the Mix Matrix channels can be used to create a stereo monitor mix (or four for a quad mix). 16-, 24- or 32-channel tapes can be made in real time by using the interstage patch outputs as direct channel feeds to the recorder.

In some cases it is desirable initially to make a "dry" recording, one without echo or other special effects, but to monitor the recording "wet", with echo or effects. This can be done simply by connecting the echo/effects return line(s) to the Mix Matrix auxiliary inputs rather than to the console's effects inputs; the Aux In level controls will then enable the effects to be mixed into the monitors, but since the tape machine is fed from the master program outputs, it remains "dry."

FOR TELEVISION PRODUCTION

For studio production work, the Mix Matrix is helpful in creating mix-minus feeds. These are sent to boom mic and camera operators' IFB systems (interruptible foldback intercoms), as well as to contestants or separated groups of people who must not hear certain portions of the program. The Mix Matrix also proves useful in creating a full mono mix of the show for a VTR feed (and the soon-to-come stereo T.V. sound will be easy to achieve using two Mix Matrix channels).

For remote production, pre-production, or post-production work, the Mix Matrix might best be used to feed various VTR's with different audio mixes, to provide primary and secondary feeds to transmission, or even to mix a reference tape (mono or stereo cassette).

FOR THEATRICAL PRODUCTION

The typical production has several scenes, each with different mic setups, and some with special effects. If the program busses are utilized to mix the different scenes, each may be turned ON as required using the Master Program ON/OFF switches. Each scene, however, will need to be fed to the various house speakers, and this is where the Mix Matrix is very useful. The 8 program busses can be assigned to spread across the stage, across audience fill channels, or into special effects speakers. The Mix Matrix ON/OFF switches may be used to activate the "effects" speakers on cue.

REAR PANEL

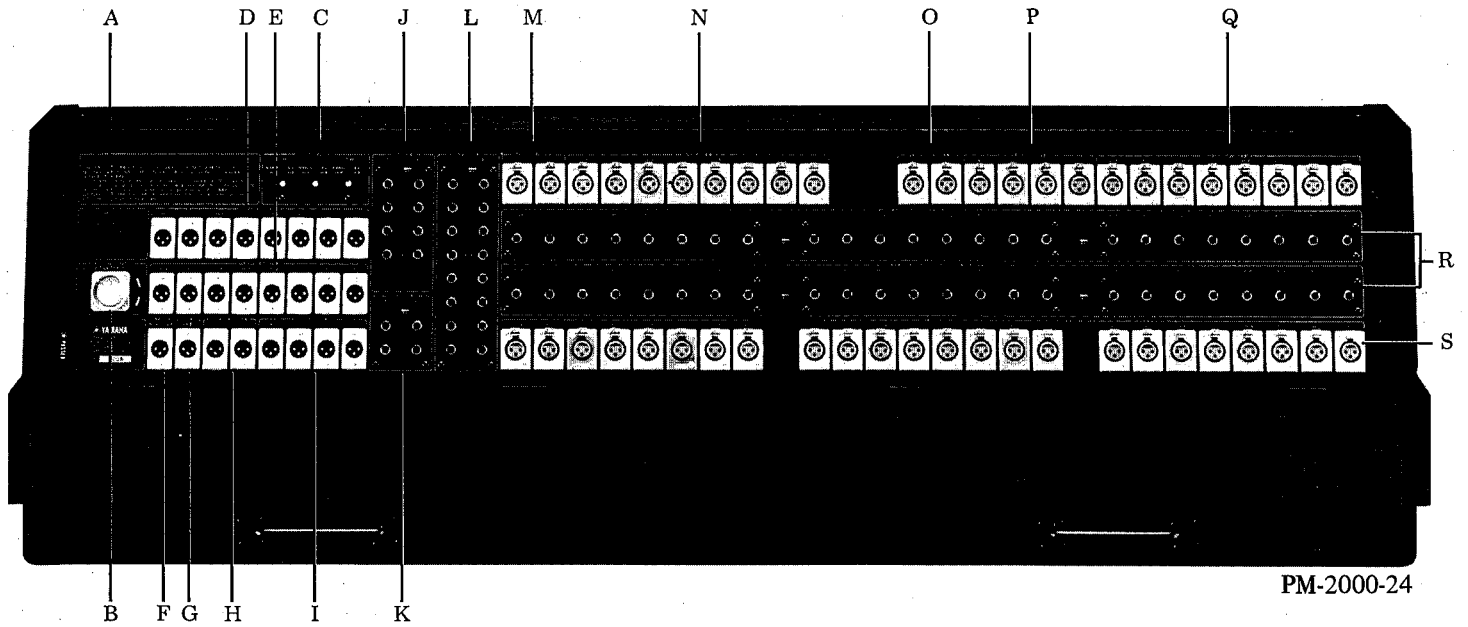

PM-2000-24

- A. PHANTOM POWER MASTER switch turns the 48V supply ON and OFF. When this switch is ON, 48V on individual channels may still be turned ON and OFF via front-panel switches. (41V for U.S. model)
- B. DC POWER INPUT connector accepts "umbilical" power cable from remote supply.
- C. MASTER GAIN switches change the overall gain of the console from normal to 10dB additional for 3 separate circuits: ECHO, FOLDBACK and PROGRAM.
- D. PROGRAM BUS OUTPUTS 1 through 8 are derived from the 8 program mixing busses, after the Master Faders.*
- E. MATRIX OUTPUTS 1 through 8 are derived from the 8 Mix Matrix channels, after the Matrix Master controls.*
- F. PHONES OUTPUT is a mono blend of the stereo phones mix developed in the Foldback/Phones module; output level follows the setting for the stereo phone jacks.*
- G. TALKBACK OUTPUT carries the Oscillator/Noise Generator signal, TB program input, or TB mic input, depending on the switch status of the TB module.*
- H. ECHO OUTPUTS 1 & 2 are derived from the 2 Echo mixing busses, after the Echo Master controls.*
- I. FOLDBACK OUTPUTS 1 through 4 are derived from the 4 Foldback mixing busses, after the Foldback* Master controls.
- J. FOLDBACK MASTER PATCH POINTS 1 through 4 (IN and OUT jacks) come after the foldback mixing bus summing amplifiers but ahead of the Foldback Master controls; nominal level is -6dB (Re: 0.775V).**
- K. ECHO MASTER PATCH POINTS 1 & 2 (IN and OUT jacks) come after the echo mixing bus summing amplifiers but ahead of the Echo Master controls; nominal level is -6dB (Re: 0.775V).**
- L. PROGRAM MASTER PATCH POINTS 1 through 8 (IN and OUT jacks) come after the program mixing bus summing amplifiers but ahead of the program Master Faders; nominal level is -6dB (Re: 0.775V).**
- M. EFFECTS INPUTS 1 & 2 apply signal to the two effects return channels in the Effects module.***
- N. AUX INPUTS 1 through 8 apply signal to correspondingly numbered Mix Matrix channels via the Aux Level controls.***
- O. ECHO SUB INPUTS 1 & 2 apply signal directly to the echo mixing busses (ahead of the Master Patch points and Master Level controls).***
- P. FOLDBACK SUB INPUTS 1 through 4 apply signal directly to the foldback mixing busses (ahead of the Master Patch points and Master Level controls).***
- Q. PROGRAM SUB INPUTS 1 through 8 apply signal directly to the program mixing busses (ahead of the Master Patch points and Master Faders).***
- R. INPUT MODULE INTERSTAGE PATCH POINTS 1 through 32 (or 24). The OUT jacks are post-EQ, and the IN jacks Pre-Fader; nominal level is +4dB (Re: 0.775V).**
- S. CHANNEL INPUTS 1 through 32 (or 24) apply signal to correspondingly numbered input modules. The nominal level may vary from -60 to +4dB (Re: 0.775V), depending on the setting of individual Input Level switches.***

**Connectors are balanced (floating) male XLR-3, nominal +4dB (Re: 0.775V) output level.*

***T.R.S. phone jacks for OUT and IN are wired in a "normalled" configuration; i. e., so long as the IN jack is not used, the OUT jack is internally wired to it for signal continuity. The OUT jack may be used as a direct output without interrupting signal flow through the console.*

****Connectors are balanced (floating) female XLR-3, nominal +4dB input level (Re: 0.775V) unless otherwise noted.*

POWER SUPPLY

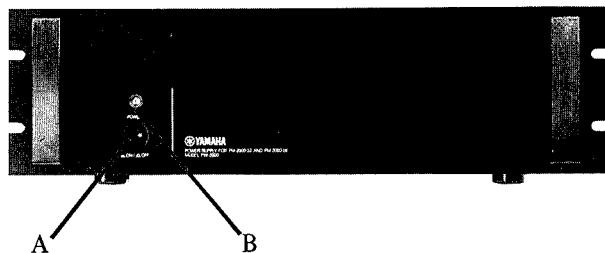

- A. **ON/OFF Switch** This alternate-action pushbutton turns the PM-2000 ON and OFF.
- B. **POWER Indicator Lamp** This red lamp is ON when the PM-2000 power switch is ON.

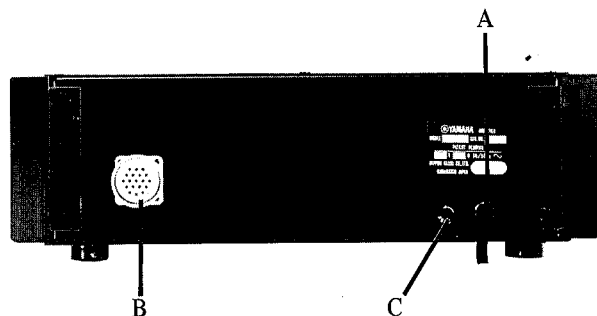

- A. **AC POWER CORD** This 3-wire (grounded) power cord is for connection to suitable 50 or 60Hz AC power mains: 120V RMS nominal for U.S. and Canadian models, and other models with selectable voltages of 110, 130, 220 or 240V RMS.
- B. **UMBILICAL CONNECTOR** This multi-pin connector mates the "umbilical" cable which brings power from this supply to the PM-2000 console itself. A twist-lock ring keeps the cable in place until you wish to disconnect it.
- C. **AC LINE FUSE** This fuse protects the primary side of the power supply transformer. If a fuse blows, replace it only with one of the same type and current rating. Repeated fuse failure suggests a fault which requires correction; do not attempt to bypass the fuse as this may permanently damage the power supply and/or the console, and will void the warranty.

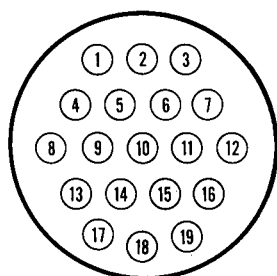

PIN	OUTPUT	FUNCTION
2	Ground	Power Supply Chassis Ground
3	Ground	
4	+24.5V Reg.	For Most of the Console's Amplifiers
5	-24.5V Reg.	
7	Ground	
12	Ground	
6	+48V (+41V*)	For Phantom Power
13	+10V	For Meter Lamps
14	Ground	
8	+16V	For Channel, Program & Matrix Switch Lamps
9	Ground	
10	+24V	For Headphone Amp, Relay & Peak Indicators
11	Ground	
15	—	—
16	—	—

*For U.S. model.

METER PANEL

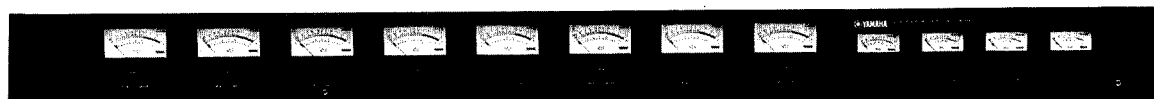

LARGE VU meters (#1 through #8) may be individually switched to indicate the level of correspondingly numbered PROGRAM Outputs or MATRIX Outputs. The meters are illuminated, have true VU ballistics, and are calibrated so that 0 VU represents a +4dBm (1.23V) output.

Four SMALLER VU meters each may be switched to indicate the level of the 4 FOLDBACK Outputs or the ECHO 1, ECHO 2, CUE and TALKBACK Outputs. The meters are illuminated, have true VU ballistics, and are calibrated so that 0 VU represents a +4dBm (1.23V) output.

SPECIFICATIONS

GENERAL SPECIFICATIONS

Frequency Response

+0, -3dB, 20Hz to 20kHz; ± 0.5 dB, 50Hz to 15kHz.

Total Harmonic Distortion

Less than 0.5% at +10dB* output, 20Hz to 20kHz;
Less than 0.1% at +20dB* output, 50Hz to 20kHz
(rising to less than 0.5% at 20Hz).

Typically less than 0.3% at +20dB output, 20Hz to 20kHz, and less than 0.03%, 50Hz to 20kHz.

Hum & Noise** (20Hz to 20kHz, input termination of 150 ohms, all output assign switches ON, Input Level switches at "-50")

-128dBm Equivalent Input Noise.

-90dB* residual output noise: all Faders down.

78dB PROGRAM OUT Signal-to-Noise ratio, Master and one Input Fader @ nominal level.

81dB MATRIX OUT Signal-to-Noise ratio, Matrix mix and Master controls @ maximum level, all Master Faders and one Input Fader @ nominal level.

77dB FB or ECHO OUT Signal-to-Noise ratio, Master level control and one FB or ECHO mix control @ nominal level.

Maximum Voltage Gain (Input Selectors at "-60dB," where applicable; rear-panel Gain Switch can add 10dB more gain.)

84 \pm 2dB, CHANNEL IN to PGM OUT;
84 \pm 2dB, CHANNEL IN to MATRIX OUT;
84 \pm 2dB, CHANNEL IN to FB OUT;
84 \pm 2dB, CHANNEL IN to ECHO OUT;
10 \pm 2dB, PGM SUB IN to PGM OUT;
20 \pm 2dB, EFFECTS IN to PGM OUT.

Channel Equalization (± 15 dB maximum)

LOW: 50, 100, 200, 350, 500Hz (shelving characteristic);

LOW-MID: 250, 350, 500, 700, 1000Hz (peaking characteristic);

HIGH-MID: 0.8, 1.2, 2, 3.5, 5kHz (peaking characteristic);

HIGH: 3.5, 5, 7, 9, 12.5kHz (shelving characteristic).

High Pass Filter

18dB/octave roll-off below 40Hz or 80Hz at -3dB points.

Oscillator/Noise Generator

Switchable sine wave @ 100Hz, 1kHz or 10kHz (1% T.H.D. @ +4dB* output), or pink noise.***

Talkback

Microphone input XLR, mic preamp, mic level control, and push-to-talk switch.***

Line input XLR, preamp, line level control.***

Inputs & Outputs

(See accompanying tables of "Input Characteristics" and "Output Characteristics".)

Crosstalk

-60dB @ 1kHz, adjacent inputs;
-60dB @ 1kHz, input to output.

VU Meters (0 VU = +4dB* output)

8 large, illuminated meters; switchable for Program or Matrix busses.

4 smaller, illuminated meters; all are switchable to Foldback busses, 2 to Echo, 1 to TB and 1 to Cue bus.

Peak Indicators

LED built into each input module turns ON when the pre-Fader level reaches 3dB below clipping.

LED built into each VU meter turns ON when post-Master Fader level reaches 10dB below clipping.

Phantom Power

48V****DC is applied to balanced input transformers (via 6.8kohm current-limiting/isolation resistors) for powering condenser microphones; may be turned ON or OFF via rear-panel phantom Master switch. When Master is ON, individual channels may be turned ON or OFF via Phantom power switches on each input module.

Finish

Black anodized aluminum panels, padded armrest, rosewood veneer cabinet.

Dimensions

24-channel: 127.7cm wide (50-1/4");
32-channel: 155.3cm wide (61-1/4");
either unit: 102.3cm deep (40-1/4")
x 40.3cm high (15-3/4").

Weight

24-channel: 146kg (322 pounds);
32-channel: 170kg (375 pounds).

Power Consumption

24-channel: 240 watts;
32-channel: 270 watts.

Accessories

Integral carrying handles, removable leatherette cover, PW-2000 power supply, and power supply DC inter-connecting cable are all included with the console.

POWER SUPPLY (PW-2000) SPECIFICATIONS

AC Line Voltage

120VRMS nominal (U.S. and Canadian models);
110, 130, 220 or 240V selectable (other models).
50 or 60Hz.

DC Output Voltages

± 24 V (for preamps, buffer amps, and line amps);
+48V (for phantom mic power)****;
+24V (for headphone amp, relay, and peak indicators);
+16V (for module lamps);
+10V (for VU meter lamps).

Finish

Black anodized aluminum;
Front panel is designed for standard 19" rack mounting.

Dimensions (W x H x D)

48 x 14 x 33.7cm (19 x 5-1/2 x 13-1/4").

Weight

15kg (33 pounds).

*OdB is referenced to 0.775VRMS (OdBm @ 600 ohms).

**Hum and Noise are measured with a 6dB/octave filter at 12.47 kHz; equivalent to a 20kHz filter with infinite dB/octave attenuation.

***Oscillator/Noise Generator and Talkback circuitry slates onto the Program, Foldback and Echo busses. The TB ON/OFF switch applies signal to the TB output XLR.

****+41V for U.S. model.

Specifications subject to change without notice.

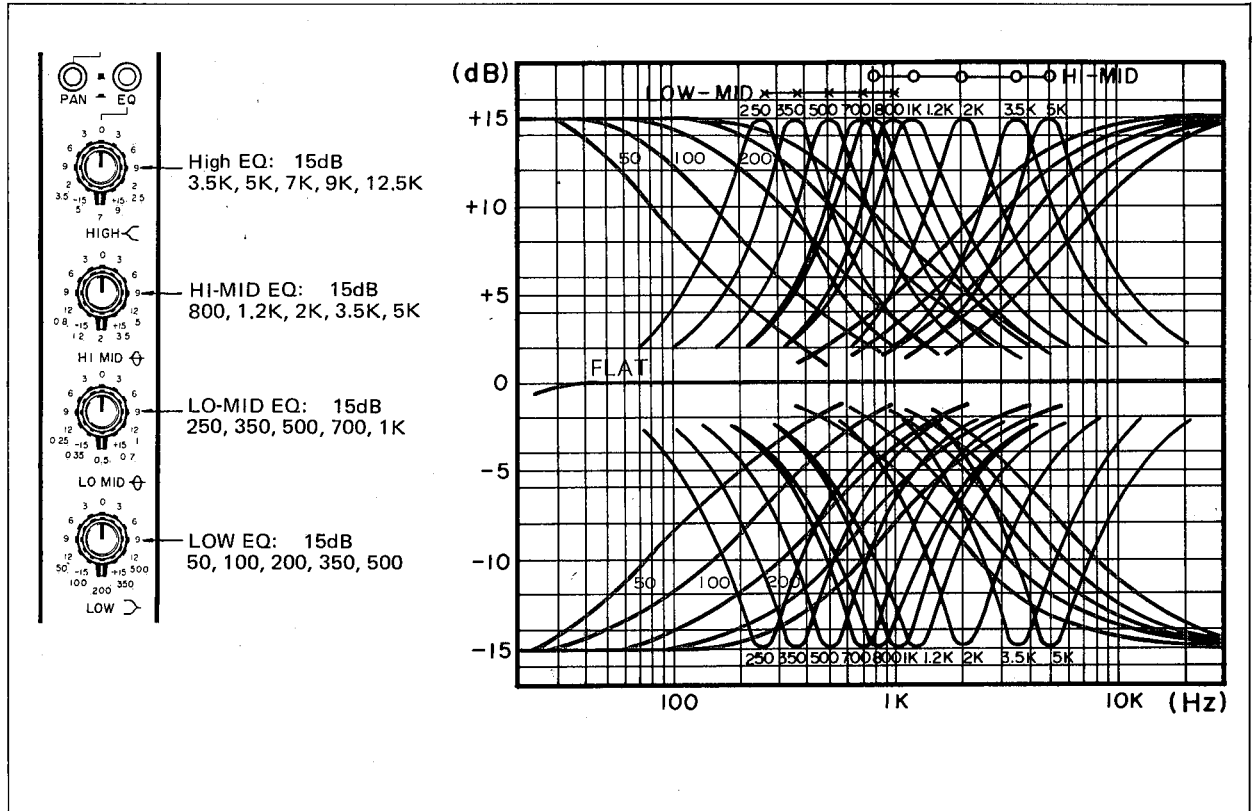

Low-Mid and High-Mid Controls

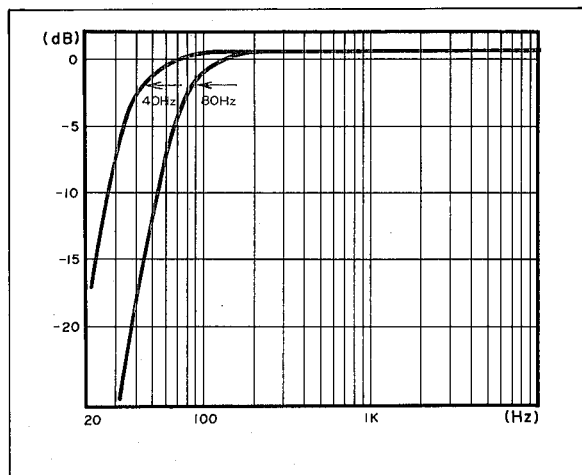

High Pass Filter Characteristics

INPUT CHARACTERISTICS

Connection	Chan/ Bus	Level Switch	Actual Load Impedance	For Use With Nominal	Sensitivity*†	Input Level*		Connector In Console**
						Nominal	Max. Before Clip	
CHANNEL INPUTS	1 – 24 or 1 – 32	–60	1 kohm	50 to 250 ohm microphones or 600 ohm line level sources	–80dB (0.08mV)	–60dB (0.78mV)	–40dB (7.8mV)	XLR-3-31
		–50	1 kohm		–70dB (0.25mV)	–50dB (2.5mV)	–30dB (25mV)	
		–44	1 kohm		–64dB (0.49mV)	–44dB (4.9mV)	–24dB (49mV)	
		–38	1 kohm		–58dB (0.98mV)	–38dB (9.8mV)	–18dB (98mV)	
		–32	1 kohm		–52dB (1.93mV)	–32dB (19.3mV)	–12dB (193mV)	
		–26	1 kohm		–46dB (3.9mV)	–26dB (39mV)	–6dB (390mV)	
		–20	1 kohm		–40dB (7.8mV)	–20dB (78mV)	0dB (780mV)	
		–14	1.7 kohms		–34dB (15.5mV)	–14dB (155mV)	+6dB (1.55V)	
		–8	2.6 kohms		–28dB (31mV)	–8dB (310mV)	+12dB (3.1V)	
		–2	3.1 kohms		–22dB (61.6mV)	–2dB (616mV)	+18dB (6.2V)	
		+4	3.3 kohms		–16dB (123mV)	+4dB (1.23V)	+24dB (12.3V)	
AUX IN	1–8		5 kohms	600 ohm lines	–6dB (390mV)	+4dB (1.23V)	+24dB (12.3V)	XLR-3-31
EFFECTS IN	1, 2		5 kohms	600 ohm lines	–16dB (123mV)	+4dB (1.23V)	+24dB (12.3V)	XLR-3-31
PGM SUB IN	1–8							
FB SUB IN	1–4		1 kohm	600 ohm lines	–6dB (390mV)	+4dB (1.23V)	+24dB (12.3V)	XLR-3-31
ECHO SUB IN	1, 2							
TB MIC IN			1 kohm	50 to 250 ohm mics	–70dB (0.25mV)	–50dB (2.5mV)	–28dB (31mV)	XLR-3-31
TB LINE IN			5 kohms	600 ohm lines	–40dB (7.8mV)	–20dB (78mV)	+2dB (980mV)	XLR-3-31
CH PATCH IN	1–24or32		1.3 kohms	600 ohm lines	–16dB (123mV)	+4dB (1.23V)	+24dB (12.3V)	TRS Phone Jack
PGM PATCH IN	1–8							
FB PATCH IN	1–4		10 kohms	600 ohm lines	–16dB (123mV)	–6dB (390mV)	+24dB (12.3V)	TRS Phone Jack
ECHO PATCH IN	1, 2							

OUTPUT CHARACTERISTICS

Connection	Chan/ Bus	Actual Source Impedance	For Use With Nominal	Output Level*		Connector In Console**
				Nominal	Max. Before Clip	
PGM OUT	1 – 8	150 ohms	600 ohm lines	+4dB (1.23V)	+24dB (12.3V)	XLR-3-32
MATRIX OUT	1 – 8					
FOLDBACK OUT	1 – 4					
ECHO OUT	1, 2					
TB OUT						
CH. PATCH OUT	1–24or32	600 ohms	10 kohm lines	+4dB (1.23V)	+24dB (12.3V)	TRS Phone Jack
PGM PATCH OUT	1 – 8	600 ohms	10 kohm lines	–6dB (390mV)	+24dB (12.3V)	TRS Phone Jack
FB PATCH OUT	1 – 4					
ECHO PATCH OUT	1, 2					
PHONES OUT		150 ohms	600 ohm lines	+4dB (1.23V)	+24dB (12.3V)	XLR-3-32
HEADPHONES	1, 2	33 ohms	8-ohm phones	–4dB (489mV)	+6dB (1.55V)	TRS Phone Jack
			600 ohm lines	+10dB (2.45V)	+20dB (7.8V)	

*0dB is referenced to 0.775V RMS.

**All XLR connectors are floating (balanced channel inputs) and transformer-isolated. TRS phone jacks are unbalanced, with separate audio common and chassis ground connections (except headphone jacks, wired Tip=Left, Ring=Right, Sleeve=Common).

†Sensitivity is the level required to produce a nominal output of +4dB (1.23V) or the specified nominal output level if other than +4dB. NOTE: SENSITIVITY MAY BE INCREASED ANOTHER 10dB by rear-panel Gain Switches (except for Aux In).

REGARDING DESIGNATION OF INPUT & OUTPUT LEVELS

In these specifications, when dB represents a specific voltage, 0dB is referenced to 0.775V. "dB" is a voltage ratio, whereas "dBm" is a power ratio. 0dBm is referenced to 1 milliwatt (0.775 V RMS driving a 600-ohm termination). For example, when 12.3V is fed to a high impedance, the level is designated "+24dB". When +24dB (12.3 volts) drives a 600-ohm termination, the level is designated "+24dBm" (250 milliwatts).

If the voltage remains the same when the termination

changes, the power level changes; +24dB (voltage) driving a 300-ohm termination would be +27dBm (500 milliwatts), and +24dB driving a 150-ohm termination would be +30dBm (1 watt). The signal voltage level in "dB" is specified, wherever applicable, (1) to avoid confusion about levels when the mixer is connected to various low impedance of unknown impedance, and (2) to be more accurate in specifying *voltage* levels across high impedance circuits.

INSTALLATION

POWER MAINS

U.S.A. and Canadian models are designed to operate from 110 to 120V AC, 50 or 60Hz power mains.* The mixer must be AC grounded for safety and for proper shielding; a 3-wire power cable is provided for this purpose. If a 3-wire outlet is not available, or if there is any chance the outlet may not be grounded, a separate jumper wire must be connected from the mixer chassis to an earth ground. Cold water pipes generally provide good grounds, although if they are insulated by a length of PVC pipe or a water meter, cold water pipes are not good grounds. (An electrical wire bypasses some meters, supplying ground continuity for the cold water pipes.) Avoid hot water pipes and gas pipes. When in doubt, use a length of copper pipe driven into moist, salted earth, burying at least 1.5m (5 ft) of pipe. Alternatively, use one of the new chemical type ground rods.

Connect the mixer to the power mains **ONLY AFTER CONFIRMING THAT THE VOLTAGE AND LINE FREQUENCY ARE CORRECT.** (By all means, **USE A VOLTMETER** . . . it can save your equipment and the show.) It is also a good idea to check for proper polarity in the AC outlet. The Power Switch on the mixer should be Off and the "umbilical" cable disconnected before connecting the console to the mains. As a precaution, disconnect the console from the mains while audio cables are being installed.

CAUTION: Severe over voltage or under voltage in the power mains can damage the console's circuitry. Always check the AC line before connecting the mixer's AC power cable. Use an RCA Power Line Monitor, or any suitable AC voltmeter. The power line must measure more than 105V AC and less than 130V AC (rms). Some lines are "soft," meaning that the voltage drops when the line is loaded due to excessive resistance in the power line. To be certain the voltage is adequate, check it again after turning on the console, and any power amplifiers that might be connected to the same power mains.

If power line voltages do not fall within the 105V AC to 130V AC range, do not connect the console to the AC line. Do find a suitable line or contact a qualified electrician. Failure to observe this precaution may damage the console, and will void the warranty.

THEORY OF GROUNDING

Careful grounding procedures are essential for proper operation, not only of the PM-2000, but of the entire audio system. Many grounding techniques exist, and certainly there are several ways to achieve a satisfactorily grounded audio system. Several books have been written on the subject. For further information (to complement the information presented below), consult the following sources: **THE AUDIO CYCLOPEDIA** by Howard M. Tremaine (Pub. Howard W. Sams); **SOUND SYSTEMS** by Don and Carolyn Davis (Pub. Howard W. Sams); **GROUNDING AND SHIELDING IN INSTRUMENTATION** by Ralph Morrison (Pub. John Wiley & Sons).

WARNING: In any audio system installation, governmental and insurance underwriters' electrical codes must be observed. These codes are based on safety, and may vary in different localities; in all cases, local codes take

precedence over any suggestions contained in this manual. As set forth in the PM-2000 Warranty, Yamaha International Corporation shall not be liable for incidental or consequential damages, including injury to persons or property, resulting from improper unsafe or illegal installation or use of the PM-2000 or of any related equipment; neither shall the Corporation be liable for any such damages arising from defects or damage resulting from accident, neglect, misuse, modification, mistreatment, tampering or any act of nature.

The following grounding scheme is presented in the belief that it is one of the more simple, yet effective methods available, but by no means is it the only effective method.

Grounded loops (also called "hum loops"), are often caused by multiple paths from equipment grounds to the AC main ground ("earth" ground). Ground loops tend to induce hum and allow noise to develop in an audio system; in severe instances, equipment may begin to oscillate due to ground loops. This oscillation can cause distortion and even damage to amplifiers and loudspeakers. One way to avoid ground loops is to make sure that there is just one path to the AC ground (earth ground) for the entire audio system.

The PM-2000 chassis provides a convenient point from which all other equipment in the system can derive its ground. First, isolate all auxiliary equipment grounds (usually the chassis) from the AC main ground. Then ground the auxiliary equipment (chassis) to the PM-2000 chassis via the shields of the interconnecting audio cables. To insure the success of this scheme, the PM-2000 chassis itself must be well grounded, either through the ground lead in its AC cable, or through an earth ground attached to the mixer chassis.

Much of the auxiliary equipment sold today is equipped with 2-wire AC power cables, which implies that the equipment is isolated from the AC main ground. If the equipment has a 3-wire AC cable, its chassis is probably grounded to the power mains through the rounded, center prong of the power plug; a 3-prong to 2-prong adapter may be used to interrupt that ground.

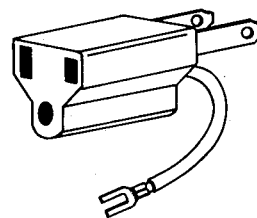

WARNING: When a chassis is not grounded directly to the AC mains, it must be grounded to the PM-2000 chassis by the shields of interconnecting audio cables; the PM-2000 thus links the remote equipment chassis to the AC main (earth) ground. Should the shield of a cable break (or in the event a cable is disconnected), it is possible for dangerous potential differences (LETHAL AC VOLTAGES) to develop between the remote chassis and any other grounded device. Therefore, it is extremely important when using this grounding scheme, especially with guitar amplifiers, that continuity be maintained between the remote chassis and the PM-2000 chassis at all times, even when the power switch is OFF.

As a precaution, test every chassis and microphone case with an ohm meter to assure that it is grounded to the power main (or earth) ground. In the previously

*Other power supplies are available for various power mains throughout the world. Consult your Yamaha PM-2000 dealer.

described grounding scheme, this can be accomplished by confirming the PM-2000's continuity to ground, and then confirming that there is virtually no resistance between the remote chassis and the PM-2000 chassis.

GROUNDING ON THE ROAD

Many of the above procedures are difficult to use on the road. For example, the telescoping shield concept is nearly impossible to use on a portable cable. Similarly, it is a difficult and time consuming process to search for a water pipe ground every time the system is moved from one performance to another. Yet portable systems can be extremely complex, and may have major grounding problems.

The telescoping shield concept can be extended to portable systems by installing a "ground lift switch" on the output of each device, and on the inputs of devices after the mixer. Since microphones are not grounded except through the mixer, there is no need for an input ground lift switch on most mixers. The diagram below shows a typical ground lift switch installation. By judicious use of these switches, each piece of equipment can be AC grounded for safety without causing ground loops.

Because of leakage currents from equipment in the audio system, and in the house, some noise currents can ride on the AC ground wire and are able to enter the audio system. This problem is usually most noticeable with sensitive equipment such as the mixer. Lifting the AC ground at the mixer can often solve this problem. However, lifting the AC ground on the mixer also lifts the AC ground on the microphone chassis, causing a safety hazard. Try connecting the mixer and any other sensitive equipment to other AC circuits. The only other apparent solution to this problem is to eliminate the noise on the AC ground, which is not an easy task. Since it has its own ground, a portable AC power distribution system connected to the house service entrance may be the most effective way to avoid all AC noises. Such a system can be designed and constructed by a qualified electrician; check local electrical codes before each use.

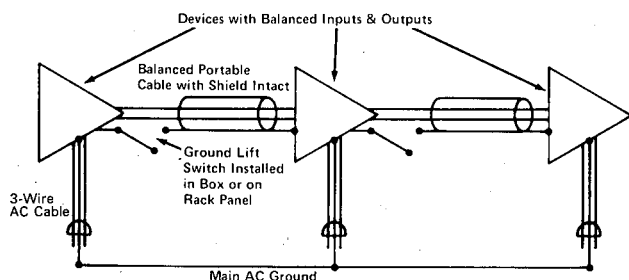

Use of Ground Lift Switch

Perhaps the best answer to portable system grounding problems, RFI, EMI, and AC noises, is to develop a versatile grounding scheme. Ground lift switches and adapters, and a portable AC power distribution system allow different grounding techniques to be tried easily and quickly when a problem occurs.

INTERCONNECTIONS

AUDIO CONNECTORS AND CABLE TYPES

The PM-2000 is fitted with only three types of audio connectors: 3-pin XLR male, 3-pin XLR female, and 3-conductor standard phone jacks (stereo).

2-conductor (twisted pair) shielded cable is best for all XLR connections. Belden No. 8412, or its equivalent, is an excellent cable due to its heavy construction. This type of cable should be used for all portable applications. A lighter duty cable, such as Belden No. 8451, or its equivalent, is suitable for permanent installation, or for permanently connected cables in portable racks. "Snake" cables containing multiple shielded pairs must be handled very carefully because the leads tend to be fragile, and a broken conductor cannot be repaired.

If low level and high level lines, or if either of these lines and speaker cables are run parallel for long distances, crosstalk may be great. In fact, the crosstalk can cause an electronic feedback loop, oscillation, and possible damage to the equipment. To minimize crosstalk, physically separate low level (microphone) cables from high level (line) cables by the greatest feasible distance. Keep speaker cables away from both low and high level signal cables. At any point where cables meet, run low level cables perpendicular to high level or speaker cables. If low and high level or speaker cables must be run parallel and in close proximity to one another, they should be bundled separately.

INTERFACE

The PM-2000 accepts balanced or floating input sources directly, with no need for auxiliary transformers. Most professional microphones, and most other low impedance professional audio devices, fall in this category. Unbalanced, low impedance equipment can also be connected directly to the input channels of the PM-180, M-508, M512, M916 and M1516, with the appropriate adapter cable (see the illustrations on the next page).

NOTE: The XL connectors in Yamaha mixers are wired to conform with DIN (European) standards, which dictate that pin 2 is high, pin 3 low, and pin 1 the shield connection. Given a positive signal at pin 1, it will be in phase with a positive signal on the high side of one of the mixers unbalanced outputs.

Use an auxiliary impedance matching transformer (high impedance to low impedance) to connect a high impedance source to the low impedance inputs of the PM-2000. Transformers can also provide isolation between balanced and unbalanced lines.

If an attenuation pad is required, always install it on the high level side of the transformer (the source side). This reduces the signal level passing through the transformer, which tends to optimize the performance of the transformer by avoiding magnetic core saturation.

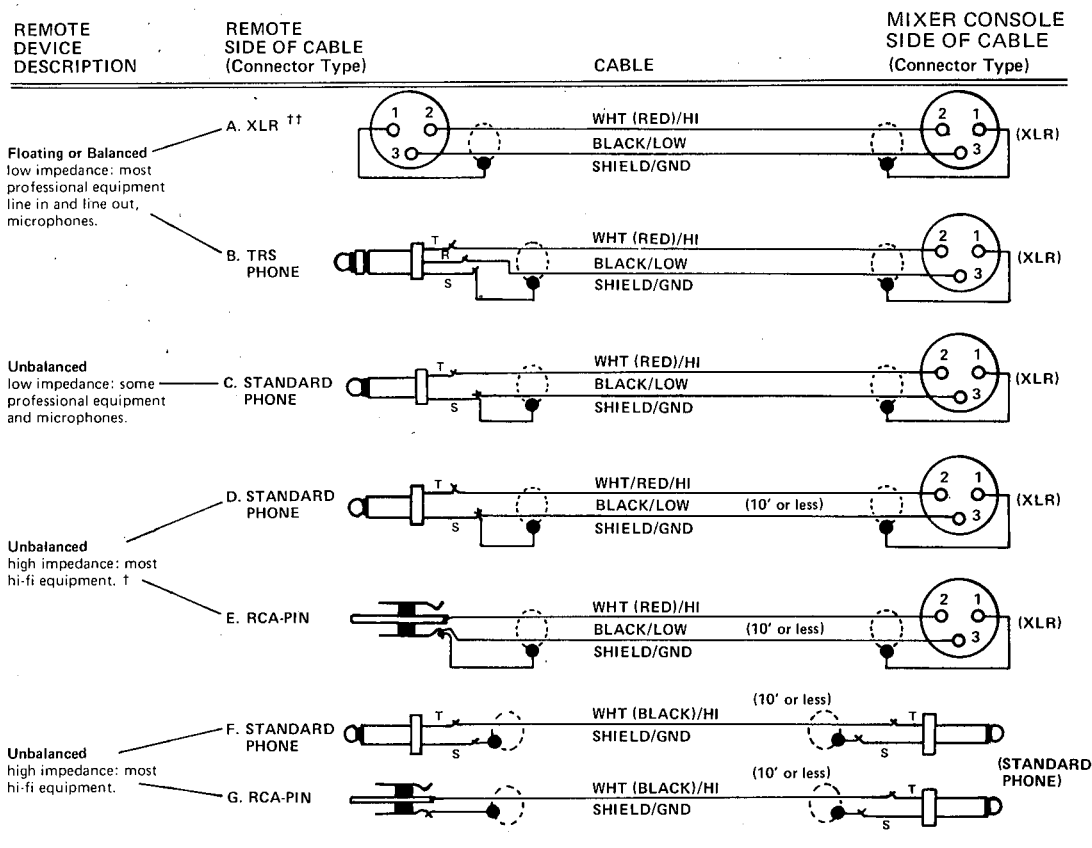

Connector and cable configurations recommended for use with the PM-2000. These cables are based on the use of auxiliary equipment that is isolated from the AC power mains.

†† This wiring configuration (Pin 2 high, Pin 3 low) matches the PM-2000 wiring and DIN standards. Much of the equipment in the U.S.A. is wired with Pin 3 high and Pin 2 low (shield is still Pin 1). In most cases involving the PM-2000, this makes no difference. However, interconnections between other manufacturer's equipment may require that Pins 2 and 3 be reversed; consult the manufacturer's literature.

† Use this cable at remote equipment, and install matching transformer with high-Z side toward remote equipment. Then use cable A to join the low-Z side of the transformer to the console. Use of the transformer at the high-Z location allows long cable runs to the low-Z connection.

PADS, TRANSFORMERS & DIRECT BOXES

ATTENUATION PADS

The most common professionally used pads are "T-pads" and "H-pads." T-pads unbalance true balanced lines (and floating lines), but work well in unbalanced circuits. H-pads are best for balanced or floating lines, but should not be used in an unbalanced circuit since they will insert a resistance in the return lead (ground). For a discussion of other types of pads, refer to the *AUDIO CYCLOPEDIA* by Howard M. Tremain (Pub. Howard W. Sams).

Always install a pad near the input of the device it feeds, with as short a length of cable as possible on the low level side of the pad. This maintains a high signal level in the longer transmission cable, reducing the effects of any induced hum and noise.

The pads illustrated can be built for 600-ohm or high impedance lines. Commercially manufactured pads are available; consult your Yamaha dealer. When connected between a 600-ohm (or lower) source and a 600-ohm (or higher) termination, pad attenuation values will remain fairly accurate. For higher impedance circuits, resistor values must be changed. To obtain the correct resistor values, multiply the values given for 600-ohm pads by the output impedance of the source device,

and divide that answer by 600. The high impedance pad values listed for the T-pads are close approximations of average hi-fi pads, based on 10,000-ohm nominal impedances.

For low level circuits, use 1/4 watt resistors. For outputs with CONTINUOUS sine wave levels above +24dBm, use 1/2 watt resistors; for CONTINUOUS sine wave levels, above +30dBm, use 1 watt, low inductance resistors. 10% tolerance is acceptable for most pads. It is possible to construct a pad within an XLR connector, but the extremely tight fit can adversely affect reliability. The Switchcraft model S3FM is a tube with a male XLR (A3M) at one end, and a female XLR (A3F) at the other. Pads using 1/4 Watt resistors can be constructed inside the S3FM. Cover the entire pad with insulation tubing before final assembly into the S3FM.

A "mini-box" fitted with male and female XLR connectors is an easy to build, rugged housing for a pad. Use stranded wire for best results.

Illustrated on next page are two typical pad construction techniques. For most applications, it will be sufficient to construct only a few types of pads: 20dB, 24dB, and 40dB pads cover almost any requirements. (Consult table on next page for schematic and resistor value information.)

dB Loss	R1 T (ohms)		R1 H (ohms)		R2	
0.5	300	16	150	8.2	180k	10k
1.0	560	33	300	18	82k	5.1k
2.0	1100	68	560	33	43k	2.7k
3.0	1710	100	820	51	27k	1.6k
4.0	2200	130	1100	68	22k	1.2k
5.0	2700	160	1500	82	16k	1k
6.0	3300	200	1600	100	13k	820
7.0	3900	220	2000	110	11k	680
8.0	4300	270	2200	130	9100	560
9.0	4700	270	2400	150	8200	470
10	5100	300	2700	150	6800	430
12	6200	360	3000	180	5100	360
14	6800	390	3300	200	4300	240
16	7500	430	3600	220	3300	200
18	7500	470	3900	220	2700	150
20	8200	510	3900	240	2000	120
22	8200	510	4300	240	1500	91
24	9100	510	4300	270	1300	75
26	9100	560	4700	270	1000	62
28	9100	560	4700	270	820	47
30	9100	560	4700	270	620	36
32	9100	560	4700	300	510	30
34	10k	560	4700	300	390	22
36	10k	560	4700	300	330	18
38	10k	560	4700	300	240	15
40	10k	560	5100	300	200	12
50	10k	620	5100	300	62	3.6

Attenuation Pad Construction and Resistor Values for High Impedance (10k-ohm) and Low Impedance (600 ohm) [shaded area] circuits.

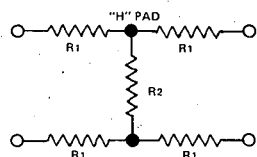
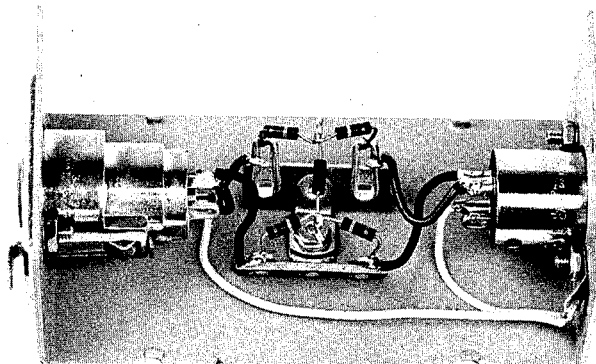
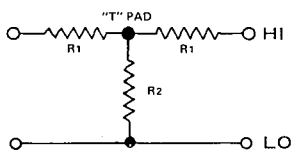
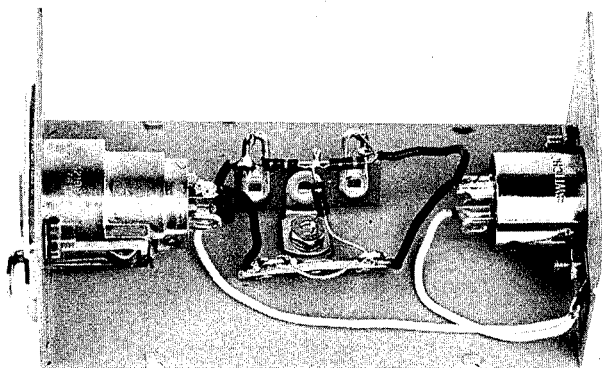

DIRECT BOXES

The term "direct box" refers to an adapter which permits a power amplifier to drive a lower level input. Direct boxes are often connected between the speaker output of an electric instrument amplifier and the input of a mixer. By using the amplifier's speaker output, the reverb, tremolo, brightness, and other sound characteristics are conveyed to the mix. The standard direct box consists of an attenuation pad that reduces the level, and an impedance matching transformer to correctly terminate the mixer's input.

A T-pad combined with a matching transformer box (described following this discussion) together make a good direct box. Connect the T-pad between the transformer's high impedance input and the speaker output of the amplifier. Approximately 20-40dB of padding is needed to prevent transformer saturation (the pad value depends on amplifier power). Another 20dB (approximately) of voltage level is lost in the transformer due to impedance matching.

As a rough guide, a 40dB T-pad should be used with amplifiers rated from 50 to 200 Watts (continuous sine wave power), and the 20dB pad should be used for smaller amplifiers. Small level variations are corrected with the mixer's input level switches and faders. If the instrument amplifier does not have a phone jack for the speaker output, prepare a cable, as shown below, which substitutes a pair of clips for the phone plug. Attach the clips to the speaker terminals, and the XLR connector to the T-pad. If hum is a problem, try reversing the clip leads on the speaker terminals.

A variation of the direct box just described, meant for low levels, contains a "Y"-adapter that enables it to be inserted between the instrument and the amplifier. The Y-adapter taps the instrument output and feeds it through an impedance matching transformer into the mixer.

This direct box variations can be assembled with the impedance matching transformer box, described in the following paragraphs, and with a special "Y"-adapter cable. A further variation is the active direct box, an isolation amplifier that has a high input impedance, and is meant for insertion between the instrument and the mixer. An excellent design for an active direct box has been provided through the courtesy of Deane Jensen, in cooperation with Westlake Audio. This unit is described at the end of this section.

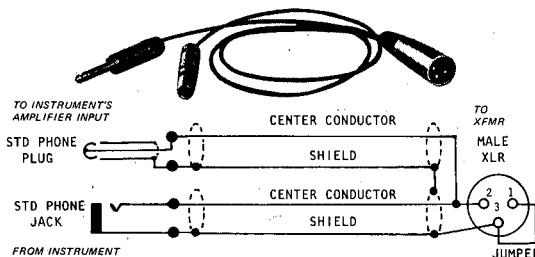
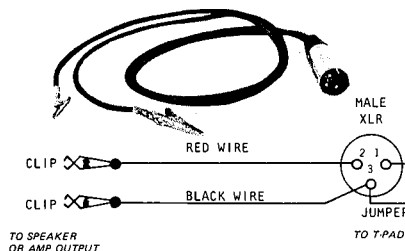

MATCHING TRANSFORMER BOX

Impedance matching transformers are manufactured by several firms. Use a transformer capable of handling nominal +4dB (1.23V) inputs with at least +24dB (12.3V) peak capability. (Alternately, use an attenuation pad to drop the level ahead of the transformer.) Because there is a voltage loss of about 20dB in the transformer, due to impedance matching, the +4dB (1.23 volts) input becomes about -6dB (0.123 volts) at the secondary. Set the mixer's Input Level Switch to -20dBm.

The transformer should have a primary impedance of approximately 30,000 ohms, and a secondary impedance of 600 ohms. For high impedance microphones, a primary impedance of 50,000 ohms and a secondary of 150 ohms is preferable. A UTC-010 transformer with the UTC-019 shield is acceptable for most applications; equivalent transformers should have similar level handling and impedance characteristics.

The transformer should be mounted in a mini-box, wired to XLR connectors with stranded wire, and connected to the auxiliary equipment with one of the cables previously illustrated. In-line transformers, such as those manufactured by Shure Brothers, Sescam, and others may be used, with suitable adapters.

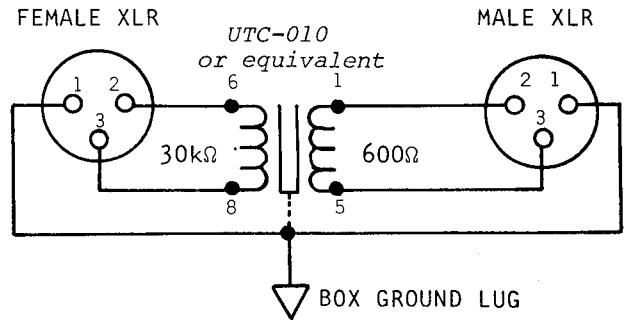
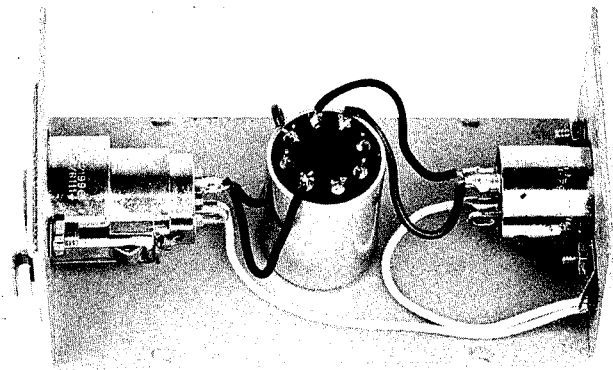

Matching Transformer Box

GUITAR DIRECT BOX (Passive)

The direct box diagrammed below represents an improvement in performance over a direct box that has been assembled from "off the shelf" components. Its transformer, pad, filter, and grounding and shielding arrangement have been specially designed for direct box use. It is not a commercial product, however, and can be assembled by any competent technician. If carefully constructed, the direct box should work well with the PM-2000. The design was included in this manual for the benefit of the user of the PM-2000, and does not represent an endorsement by Yamaha of the specific products mentioned.

The direct box can be used in three ways: 1. at the output of a standard electric guitar, without an amplifier (pad switch open, ground switched closed); 2. at the output of a standard electric guitar with a guitar amplifier also connected (pad switch open, ground switch open or closed); 3. at the output of a guitar or instrument amplifier or preamplifier (pad switched in, ground switch open or closed). The filter switch, which only works when the pad switch is closed, simulates the high frequency roll off of a guitar amp speaker. Since clipping distortion in a guitar amp creates high frequency harmonics, the filter switch, by lowering high frequency response, also cuts distortion.

The transformer was designed specifically for use in

a guitar direct box. When connected to a standard electric guitar pickup, and a mic input on a PM-2000, the transformer reflects the optimum load impedance to both the guitar pickup and the mic preamp input transformer. This maintains the frequency response and transient response of both the guitar and the PM-2000. The pad and filter were designed to maintain optimum loading. The transformer has two faraday shields, to prevent grounding and shielding problems that could cause hum in the PM-2000 or the guitar amplifier. Place the ground switch in which-ever position works best (see the previous paragraph for suggestions).

Assembly can be similar to the matching transformer box shown. Keep the phone jack isolated from the chassis of the box and during operation, keep the chassis of the box away from the chassis of the guitar amp or any other grounded object. If you decide to use a transformer other than the Jensen model JE-DB-D, it should have similar characteristics: an impedance ratio of 20k-ohms (primary) to 150-ohms (secondary), dual faraday shields, very low capacitance primary winding, and full audio spectrum frequency response. Each winding, each faraday shield, and the transformer chassis shield should have separate lead wires.

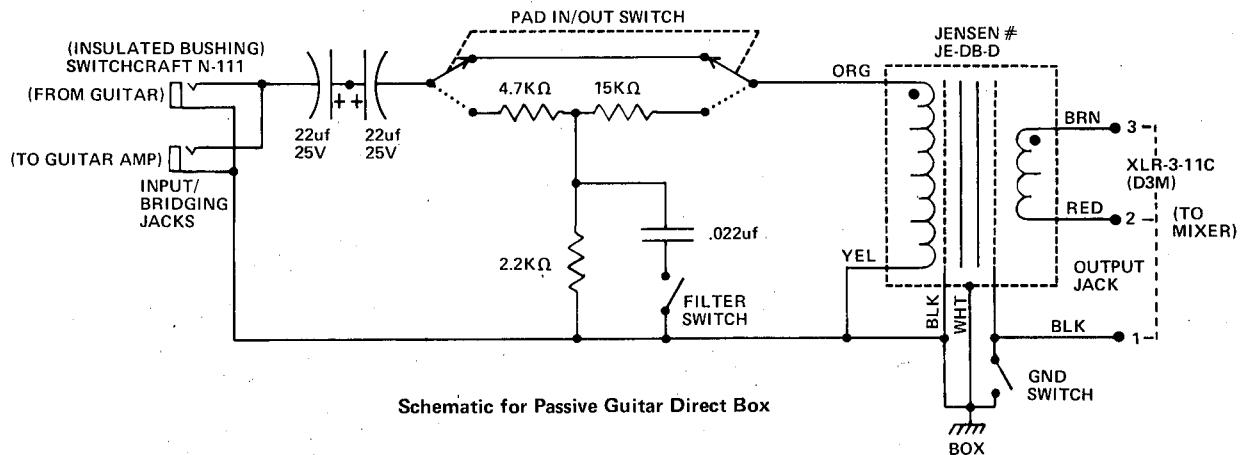

Schematic for Passive Guitar Direct Box

TRANSFORMER AVAILABILITY

The matching and direct box transformers mentioned in the preceding subsections are available from many electronic parts dealers. Yamaha does not endorse specific products by citing them herein; rather, these transformers are mentioned for convenience only. If you are unable to locate the transformers from your local electronic parts dealer, contact the manufacturer at the address shown below.

Sescom, Inc.
P.O. Box 590, Gardena, CA 90247
Phone (800) 421-1828 / (213) 770-3510

Shure Brothers, Inc.
222 Hartrey Ave., Evanston, Illinois 60204
Phone (312) 328-9000 Cable: SHUREMICRO

Triad
305 N Briant St., Huntington, Indiana 46750
Phone (219) 356-6500 TWX: 816-333-1532

UTC
150 Varick St., New York, New York 10013
Phone (212) 255-3500 TWX: 710-581-2722

A line of very high quality transformers, suitable for the most critical applications, is available directly from:

Jensen Transformer Company
10735 Burbank Blvd., N. Hollywood, CA 91601
Phone (213) 876-0059

DYNAMIC RANGE

A concert with sound levels ranging from 30dB SPL to 120dB SPL has a 90dB *dynamic range*. The electrical signal level in the sound system (given in dBm) is proportional to the original sound pressure level (given in dB SPL) at the microphone. Thus, when the program sound levels reach 120dB SPL, maximum electrical levels might reach +24dBm. Similarly, where sound levels drop to 30dB SPL, minimum electrical levels will drop to -66dBm. The program still has an electrical dynamic range of 100dB: [+24dBm] - [-66dBm] = [90dB]. This dB to dB correspondence is maintained throughout the sound system, from the original source at the microphone, through the electrical portion of the sound system, to the speaker system output. A similar correspondence holds for any other type of sound system, a recording studio system, disco system, broadcast system, etc.

Generally, the average electrical program level is +4dBm corresponding to an average sound level of 100dB SPL. This average level is usually called the *nominal* program level. The difference between the nominal and the highest (peak) levels in a program is the *headroom*. In the above example, the SPL headroom is [120dB SPL] - [100dB SPL] = [20dB]. Similarly, the electrical headroom is [+24dBm] - [+4dBm] = [20dB].

Every sound system has an inherent *noise floor*, which is the residual electronic noise in the system equipment (or acoustic noise in a room). The effective dynamic range of a system then, is equal to the

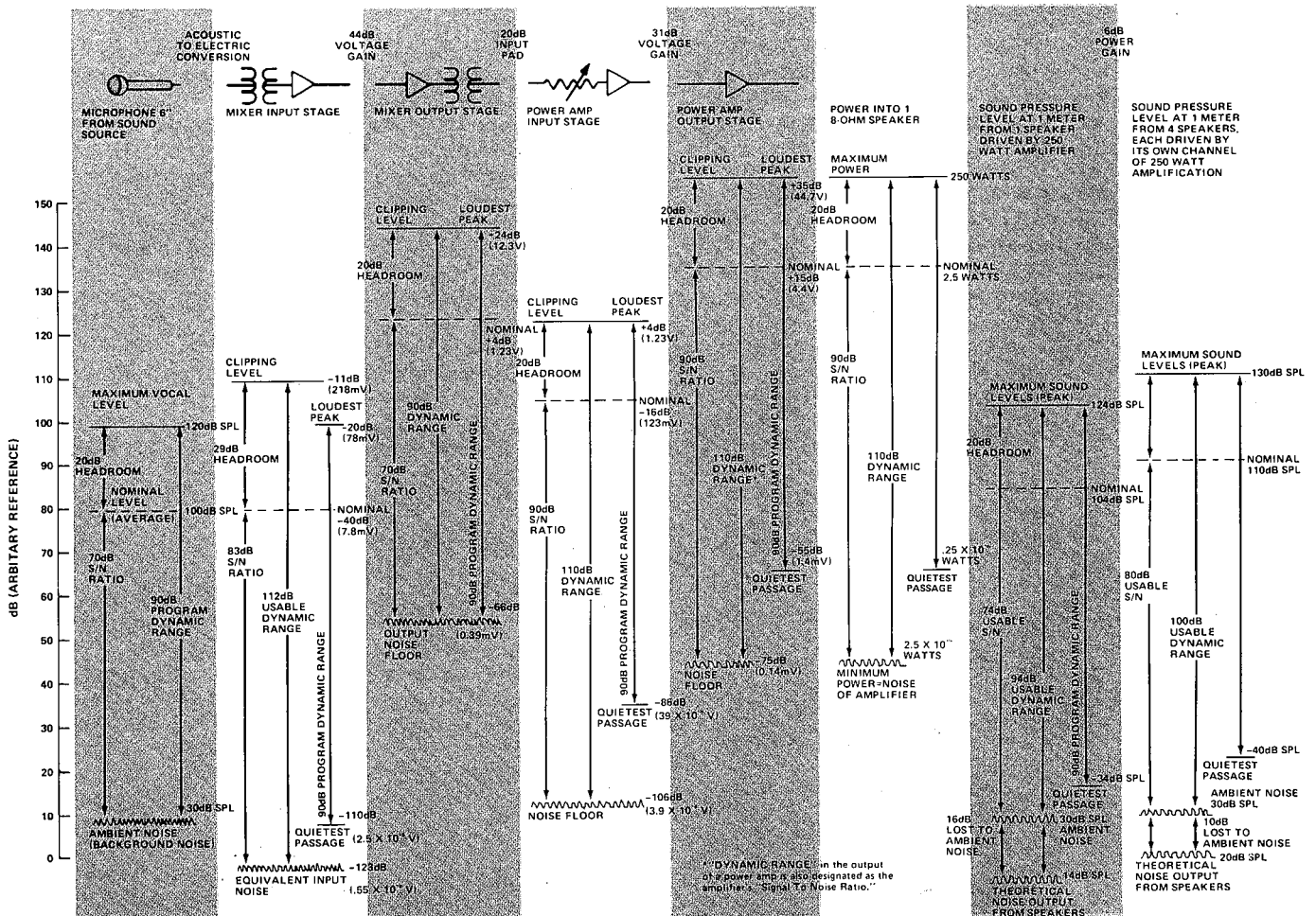

Dynamic Range in an Audio System

difference between the peak output level of the system and its noise floor. In the above example, if the system had an electronic noise floor of -66dBm , and a peak output level of $+14\text{dBm}$, its dynamic range would only be 80dB . If the original program has a dynamic range of 90dB , then 10dB of the program is lost in the sound system. There may be extreme clipping of program peaks, some of the low levels may be buried in the noise, or some of the program may be lost in both ways. Thus, it is extremely important to use wide dynamic range equipment, like the PM or M Series Mixers, in a professional sound reinforcement system.

In the special case of a tape recorder, where the dynamic range is limited by the noise floor and distortion levels of the tape itself, one way to avoid these program losses due to clipping and noise is to compress the program's dynamic range. A better way is to apply special "noise reduction equipment" which allows the original program dynamics to be maintained throughout the recording and playback process. This improvement in the dynamic range of recorded material again demands wide dynamic range from every piece of equipment in the recording/playback chain, including the mixer.

The PM-2000 is designed for these wide dynamic range applications. It has exceptionally low noise figures, and high headroom capabilities. In addition, its operating levels and input and output impedances correspond with professional requirements.

OPERATING LEVELS

Nominal professional line level is usually $+4\text{dBm}$ or $+8\text{dBm}$; that is, the *average* program level is approximately 1.23V rms ($+4\text{dBm}$), or 1.95V rms ($+8\text{dBm}$) *terminated by a 600-ohm line*. The peak level may extend to about $+24\text{dBm}$ (12.3V rms). The line (high level) input, of professional audio equipment is designed to accept levels on this order of magnitude without overdrive (clipping distortion); most professional equipment can be driven to full output by nominal $+4\text{dB}$ (1.23V) input levels, although a few units require $+8\text{dB}$ (1.95V) at their input to yield full output. See the discussion of "Gain Overlap" which follows.

Hi-fi type equipment operates at considerably lower line levels than professional equipment (with exceptions), usually at -16dB (0.123 volts) nominal levels. Notice we use the expression "dB," not "dBm." This is because "dBm" denotes a *power level* (relative to 1mW , or 0.775V rms across a 600-ohm impedance), whereas "dB" denotes a *voltage level* (as defined in this manual) relative to 0.775V rms .

The nominal -16dB (0.123 volts) level of hi-fi equipment is equal to about 123mV rms (123 one-thousandths of a volt) across a $10,000\text{-ohm}$ or higher impedance line. Peak program levels may reach or slightly exceed $+4\text{dB}$ (1.23V rms across a high impedance line). Note that a hi-fi unit capable of $+4\text{dB}$ (1.23 volts) *maximum* output into a high impedance, does not possess adequate drive for 600-ohm circuits with *nominal* $+4\text{dBm}$ level requirements. Thus, *hi-fi equipment is usually incapable of driving professional equipment to its full rated output, without first reaching a high level of distortion. More-*

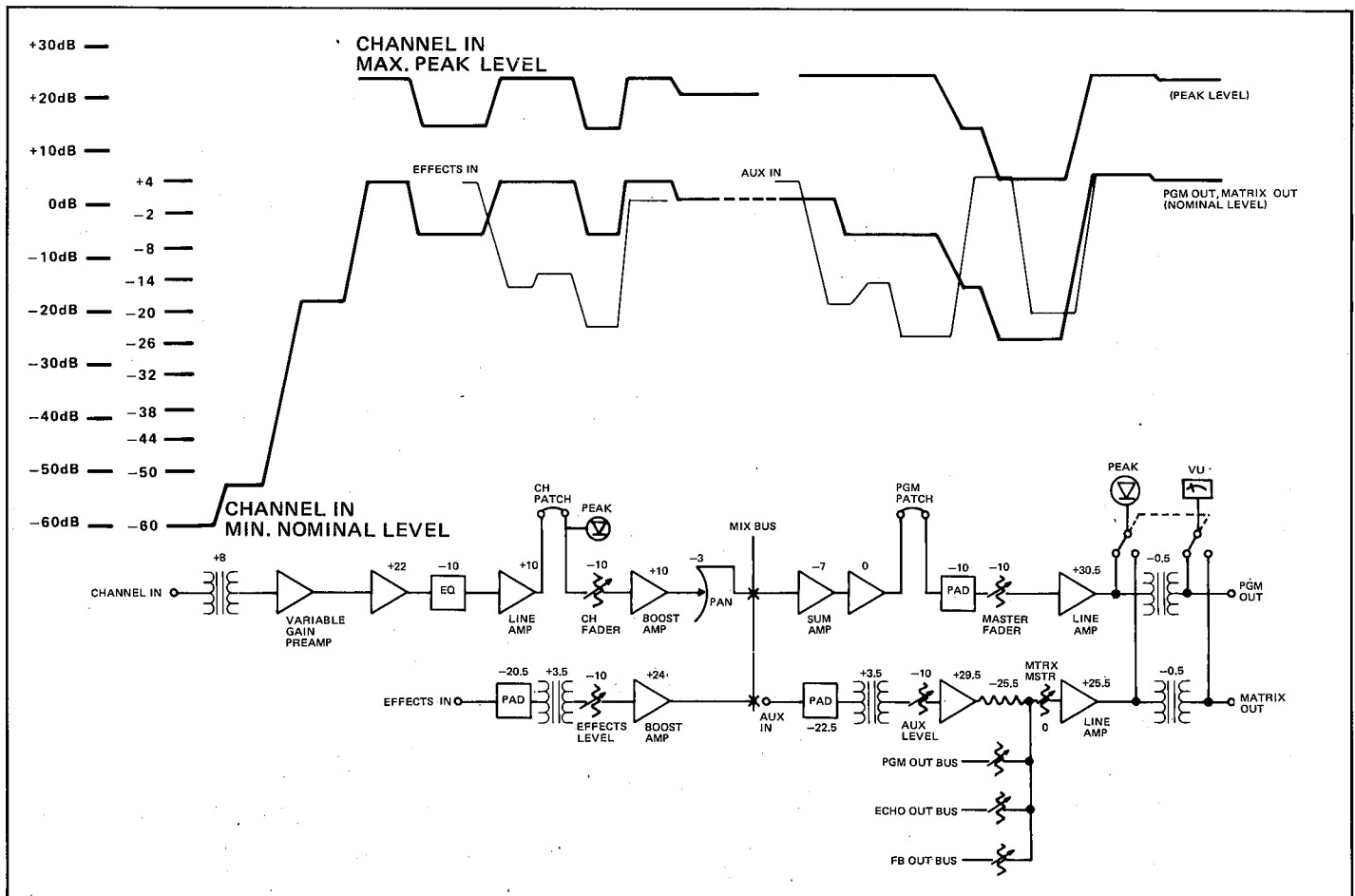

over when the output of hi-fi equipment (which is almost always meant to be operated into a high impedance) is connected directly to the low impedance input of professional equipment, the hi-fi unit "sees" a partial short circuit. This may overload the hi-fi output, or it may simply drop the output level by a few dB, depending on the circuitry. The available headroom is thereby decreased, causing peaks to "square up" (form square waves), which not only sounds bad, but can damage speakers by causing voice coil overheating. When peaks are readily distorted, the highs may be shrill or fuzzy, the midrange unnatural, and the bass muffled or muddy. In contrast, a system with adequate headroom will sound clean and transparent, and an instrument like a kick drum will have even more impact with less danger of speaker damage. The point is that impedance and level are extremely important considerations when connecting audio equipment.

GAIN OVERLAP AND HEADROOM

Built-in "Gain Overlap," that is, their +24dB output levels *exceed* the level needed to drive the inputs of most auxiliary equipment. There are several good reasons for this. Because of the peaks or transients in music and speech, the "nominal" or average level of a program is not representative of its peak level. When the VU Meters on the PM-2000 read "0VU," the nominal PROGRAM OUT A level is +4dB (1.23 volts). However, a typical music program may be "peaking" to +14dB (3.88 volts) or even higher. The Peak Indicating LED's in the meters indicate peaks that reach +14dB (3.88 volts). *At this point, there is still 10dB of "headroom" left in the console; that is, peaks could reach +24dB (12.3 volts) before clipping.* A mixer with only +18dB (6.1 volts) output capability would severely clip such peaks.

It is true that under ideal conditions, a mixer of +18dB output drive capability (14dB of headroom above nominal +4dB level) would have adequate output to avoid clipping. However, ideal conditions are seldom realized, especially in concert sound reinforcement.

In concert sound reinforcement, headroom is extremely important. Headroom is carefully adjusted throughout the system, before a show. Each device must receive its optimum input level to produce its maximum output level with the lowest noise. The challenge is predicting what the input levels from the stage will be. If the mixer has inadequate headroom the system will probably perform well until inputs from the stage exceed expected levels. At this point, the mixer begins to clip the peaks of the input waveform. Thus, the mixer becomes the weak link in the system.

The Yamaha PM-2000 console has a full 20dB of headroom above their nominal +4dB (1.23 volts) output level. This extra output headroom along with the input headroom figure of 20dB (see Specifications) means that even extreme input peaks will not overdrive the console.

Occasionally a "passive" device (no transistors or tubes) is inserted between the PM-2000 and a power amplifier in a sound reinforcement system, or studio monitoring system. Examples of passive devices are passive graphic equalizers, passive low level crossovers, pads and resistor built-out networks. Passive devices always attenuate the signal level somewhat. For example, a passive low level crossover, when properly terminated, creates a 6dB loss between the mixer and the power amplifier. Passive graphic equalizers can create more than 6dB loss at some frequencies. Fortunately, the PM-2000 has

considerably more output level than is needed to drive the inputs of most amplifiers (see discussion of power amplifier input sensitivity, below), so that passive devices may be used as desired. *This extra output capability (above that needed to drive the power amplifier) is known as "gain overlap."*

In the recording studio, or when recording live performances, for that matter, the PM-2000's wide headroom is very useful. While it is true that most professional tape machines are subject to tape saturation above input levels of +15dB, the PM-2000's +24dB output drive very definitely makes a difference. If clipping were present in a mixer's output to the tape machine, that clipping would be audible. Even the output of a +18dB mixer, if clipped, would be audible because clipping is "hard" distortion, whereas tape saturation is "gentle" distortion. This suggests that, when using a +18dB output mixer, the mixer output level is the greatest distortion-causing factor, not tape saturation. Since the PM-2000 does not clip until levels +24dB, the tape, not the console, becomes the limiting factor.

CALCULATING AND USING GAIN OVERLAP

Some auxiliary devices have input sensitivities rated like this: "nominal input sensitivity +4dB." Others may be rated like this: "input sensitivity: +4dB for rated output." This later rating is typical of many power amplifiers. The difference between these ratings is subtle, but very important. In the first device, with a *nominal* input sensitivity of +4dB (1.23 volts), adequate headroom is *implied* above +4dB (1.23 volts), (actual headroom may be stated in another specification). In the second type of device, *no* headroom is implied. A +4dB (1.23 volts) input signal to this second device drives it to full output. Peaks above +4dB (1.23 volts) will be *severely clipped*. Thus, the two devices, with the same number used for an input sensitivity rating, actually have very different input sensitivities.

A power amplifier is a good example. Assume a power amplifier with an input sensitivity rated like this: "Input Sensitivity: +14dB (1.23 volts) for full rated output." Connecting the output of the PM-2000 to the input of this amplifier will result in severe program clipping if the mixer is driven to peaks above 0VU (+4dB, 1.23 volts).

To overcome this problem, first choose a headroom figure; typically 10dB for speech or concert reinforcement, 15 to 20dB for high quality music reproduction or recording. Then, calculate the "nominal" input sensitivity for the power amplifier which will be equal to its rated input sensitivity for full output minus your chosen headroom figure. If you selected 10dB, the calculated power amplifier "nominal" sensitivity is -6dB (388mV). Thus, if the console is operated at a nominal output level of -6dB (388mV), any program peaks within the 10dB headroom figure selected will not "clip" the power amplifier. Since the console normally operates at a nominal output level of +4dB (1.23 volts), to make it operate at -6dB (388mV), insert a 10dB pad, constructed according to the 600-ohm tables shown.

Many power amplifiers have input attenuators instead of "volume controls." An input attenuator is the very first component in the circuit of the amplifier, while a volume control may be placed after several amplification stages. The input attenuator may be used in place of the pad described above, if test equipment is available to calibrate the dB of attenuation needed.

Yamaha P2200, P2100 and P2050 professional power amplifiers have dB-calibrated input attenuators which greatly simplify the whole process described above. VU meters indicate the instantaneous output power of the amplifier. This feature, ample output power, and ability to drive complex multi-speaker loads, make them a good choice for all types of professional work.

INTERFACE WITH CREATIVE AUDIO EQUIPMENT

A matching transformer may allow the connection of a high impedance output to a low impedance professional input. Matching transformers can create a low impedance cable run for better response and noise characteristics, or to help simplify grounding procedures. Some 10 to 20dB of voltage level drop occurs in a matching transformer as voltage drive (at the high-Z side) becomes converted to current drive (at the low-Z side). Moving the PM-2000 Input Level switch from the -20 to the -32 or -38dB position compensates for the lost signal. Some increase in noise may occur from making up gain lost in the matching transformer by increasing the gain of the mixer, but it is seldom noticeable.

The line outputs of most professional equipment are more than adequate to drive semi-pro (creative audio) inputs. In fact, they can easily overdrive the input. One easy method of avoiding overdrive is to connect a 20dB or 24dB, 600-ohm "T-pad" across the line from the professional (+4dBm) output to the creative audio input, which is typically -10dB (0.31V) to -16dB (0.12V). Padding is preferable to either lowering the output level setting of the professional unit or lowering the input level control setting on the creative audio device because either of these practices risks overdrive and may hamper the ability to fade (lower) the program levels. Padding permits the level controls and faders to be set at the point which yields maximum headroom, best signal-to-noise characteristics, and ample control range.

Professional mic level (-50dB, 2.45mV) outputs are not capable of driving hi-fi line inputs, although they will drive most creative audio mic inputs. Use a microphone pre-amplifier to drive any line level input from a mic level source.

ADDING AN ADDITIONAL 10dB OF GAIN TO THE PM-2000 OUTPUT STAGES

In most instances, the 84dB overall gain available between the PM-2000 channel inputs and the echo, foldback or program outputs is more than adequate. Excess gain in the output stages would only require that the master faders be operated at too low a setting, taking away from the range of control, or the input channels would be operated at too low a gain, adding noise to the signal.

The PM-2000 incorporates 3 rear-panel Gain Switches that enable you to obtain 10dB more gain for the Echo, Foldback and/or Program output circuits. The gain is actually provided by bypassing built-in 10dB attenuators in these circuits.

There are a number of applications where this extra 10dB of gain is helpful. For instance, in a theatrical presentations or religious services where the microphones are at a distance from relatively low-level speech, the program, echo and foldback gain can be increased to make up for the weak input signal.

Separate switches are provided because the need for this higher gain might be restricted to only one or two of the three output circuits. Remember that the Gain Switches come after the master insert points (see diagram), and the extra gain therefore affects any devices which might be inserted in those patch points. A typical example where this feature is useful might occur where the 84dB overall gain (NORMAL switch position) is adequate for the program and echo circuits, but a passive graphic equalizer is inserted in the foldback insert point. The passive equalizer has unavoidable insertion loss, so the extra 10dB of gain available by switching the FB Gain Switch to HIGH position comes in handy.

Remember, it is not beneficial to kill excess gain with the Master or Channel faders, or with the Input Level Switches. Unless the extra gain is needed, leave the Gain Switches set at their NORMAL (84dB) setting.

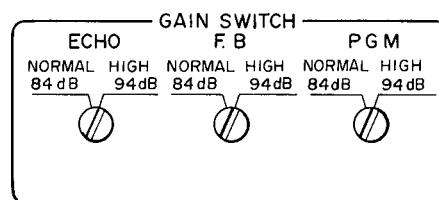

PM-2000 Rear Panel

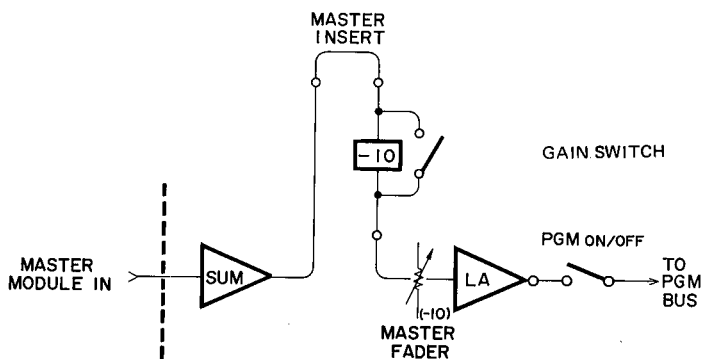

Master Program Circuit shown — similar for Echo or Foldback

APPENDIX

MAINTENANCE

PANEL & CABINET CLEANING

The black panels should be cleaned with a damp sponge. Stubborn soil can be removed with a mild detergent solution, such as dishwashing detergent. Strong detergents and chemical solvents may damage the plastic fittings.

The wood veneer cabinet will retain its beautiful finish with very little care. When it looks dull or soiled, apply any liquid or paste furniture polish and buff with a soft cloth; aerosols should be avoided because the solvents may attack adjacent portions of the console, especially the meter faces.

SPARE PARTS

The PM-2000 is built for high reliability, but accidents and failures may occur. A spare module or power supply can save the show in just seconds. We recommend that in all critical applications, one spare of each module, and one spare power supply (with cable) be kept handy. These items are available from your PM-2000 dealer.

FUSE REPLACEMENT

The rear panel of the power supply is fitted with a fuse holder for the AC line. The fuse should be replaced with one of the identical value and type. If a fuse continues to fail, do not install a higher value fuse; find the cause of the failures and correct it. In the event the problem cannot be located, contact your Yamaha PM-2000 dealer.

ACCESS TO THE CONSOLE INTERIOR

WARNING: There are no user-serviceable parts inside the PM-2000. Only qualified service personnel should attempt to open the meter panel, remove a module, or gain access to the inside of the console or power supply for any purpose. Lethal voltages are present inside the power supply, and the AC line cord and console umbilical cord should be disconnected prior to opening it.

While a module may be removed and replaced with the console in operation, it is suggested that extreme care be used to avoid short-circuiting the module against adjacent parts. Better still, turn OFF the power supply and disconnect the AC line cord whenever practical before removing or replacing a module. To remove a module, lift the armrest up and set it aside. This exposes the securing screw and an adjacent hole in the front of each module. Loosen the screw and withdraw it from the threads in the console frame. Then insert the screwdriver fully into the hole to the right of the screw, and pull the screwdriver forward to disengage the connector at the rear of the module from the mating connector in the console frame. Set aside the screwdriver, lift the front edge of the module, and withdraw it from the console.

Two meter lamps are provided for each VU meter, one on either side. A lamp may be removed by pulling its lamp holder out of the rubber grommet, replacing the lamp, and reinserting the lamp into the grommet. Access to the meter pod itself is obtained by removing the screws from the top of the pod and tilting it backward.

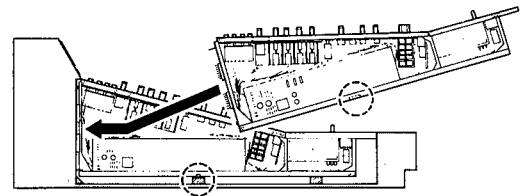
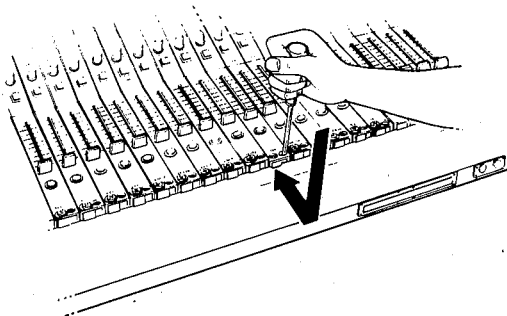
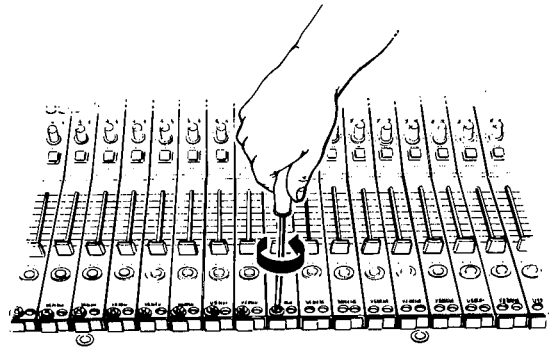
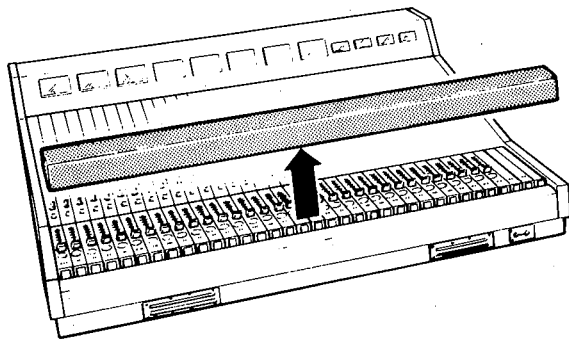

(Module Removal Sequence)

PRE/POST JUMPERS

PM-2000 input modules come factory wired so that the POST position on the echo and foldback pre-post switches is always post-fader, equalizer and filter. However, the echo PRE send is factory wired so the signal is derived pre-fader but post (after) the equalizer and filter. This means that changes in fader position may or may not affect the echo send (depending on the pre-post setting), but EQ of filter changes always affect the echo send.

The foldback PRE send is factory wired so that the signal is derived pre-fader, equalizer and filter. Thus in pre mode, the foldback send is not subject to the fader, EQ or filter.

Yamaha recognizes that various sound systems have specific design requirements, and that our factory chosen echo and foldback PRE pick-off points may not always be "ideal" for a given application. Therefore each PM-2000 input module contains easily re-settable jumpers which determine whether the PRE position is pre-fader (but post-EQ and filter) or pre-fader, equalizer and filter.

CAUTION: There are no user-serviceable parts inside the PM-2000. Only qualified service personnel should attempt to open the console, work on circuit boards, etc. The information regarding pre-post jumpers is provided here only so that the user may understand the function and may recognize that the alteration of pre-function is a routine task for a qualified service person. Yamaha neither authorizes nor encourages unqualified personnel to work on module interiors or console internal wiring.

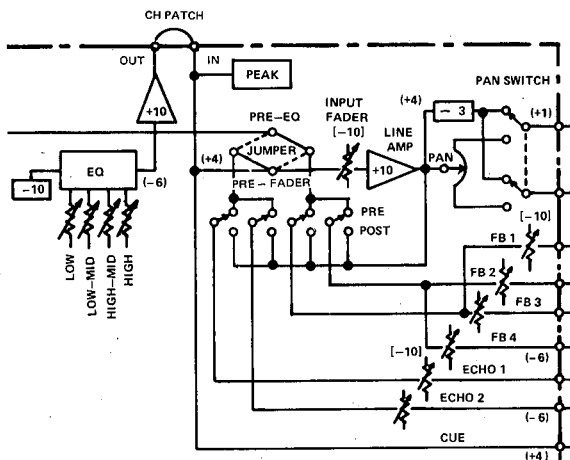

Moving the echo PRE pick-off point changes the function of both echo pre-post switches, but does not affect the foldback circuit in any way. Similarly, moving the foldback PRE pick-off point changes the function of both foldback pre-post switches, but does not affect the echo circuit.

TO MODIFY THE PRE/POST JUMPERS

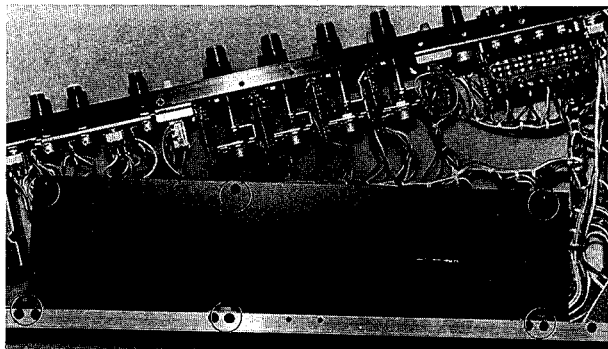

1 — Remove the input module and place it on a soft work surface. Remove the 3 pan-head Phillips screws that secure the circuit board cover plate. Lift the plate off carefully so its 3 tabs release from the module frame.

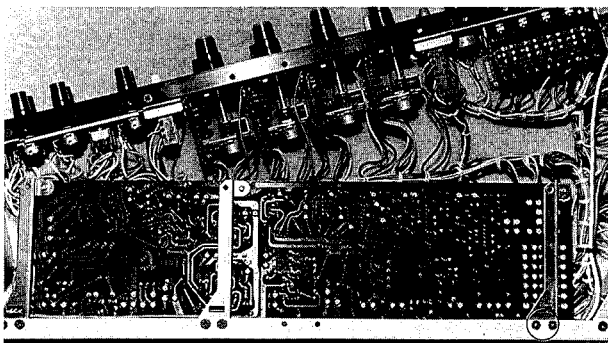

2 — Remove the 2 flat-head Phillips screws that secure the bracket at the rear of the circuit board to the module frame. It is not necessary to remove the screw that holds the bracket to the circuit board.

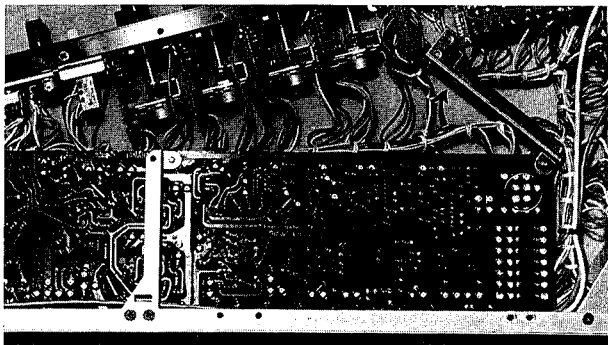

3 — Swing the bracket aside to gain full access to all 4 jumper-wire solder posts.

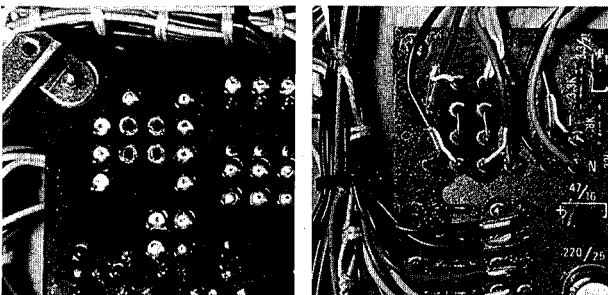

4 — Remove the solder from the 4 posts, using a solder puller, wick, or similar technique.

5 — Turn over the module for access to the component side of the circuit board. Shown here is the factory-supplied jumper arrangement, i.e., Echo = POST, and Foldback = PRE).

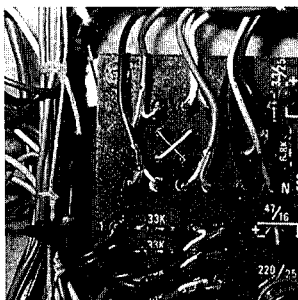

6 – For Echo = PRE, and Foldback = POST, cross jumpers as shown here. Note that at least one of the crossed wires should be insulated to avoid a short-circuit.

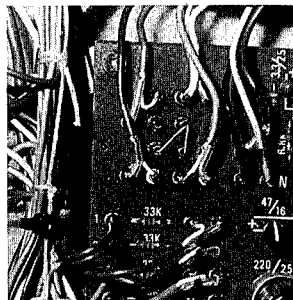

7 – For Echo = POST, and Foldback = POST, connect jumpers as shown here.

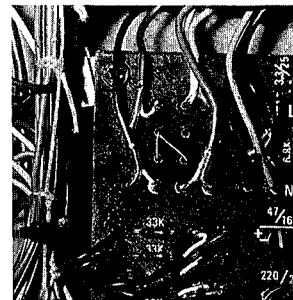

8 – For Echo = PRE, and Foldback = PRE, connect jumpers as shown here.

NOTE: When jumpers have been resoldered, reattach the circuit board mounting bracket and cover plate, and reinstall the module in the console.

TRAVEL CASE

The PM-2000 disassembles into two pieces, the power supply and the console, The console has carrying handles and can be transported locally in a van without a case. However, for protection of the unit, and certainly for heavy cartage (commercial trucking or air freight

as examples), we recommend you use additional travel cases. If you buy custom built cases, they should meet "ATA-300" specifications (ATA=Air Transport Authority). The following dimensional diagrams provide the internal dimensions (inside the foam) needed to accommodate the console and the power supply.

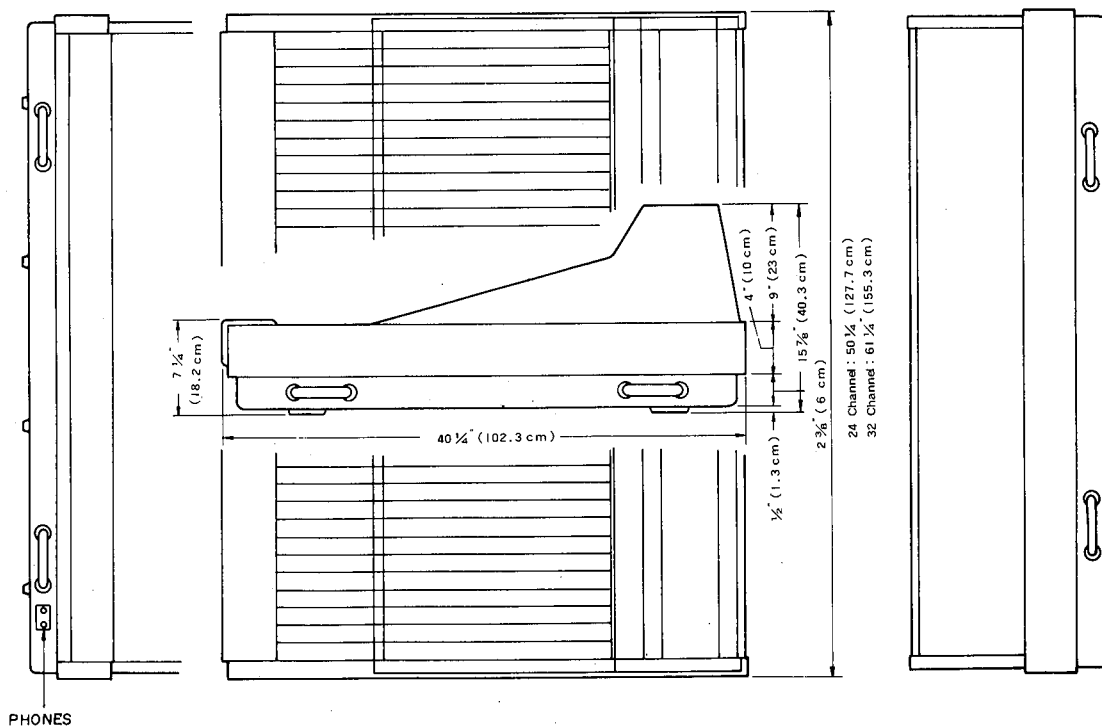

PHONES

Weight
 24-Channel : 324 pounds (146 kg)
 32-Channel : 375 pounds (170 kg)

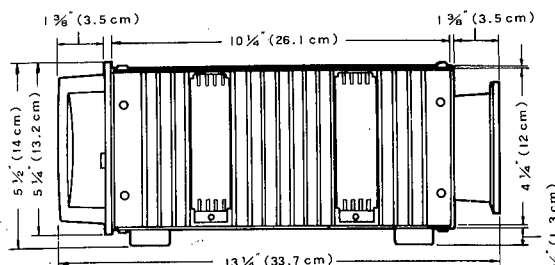
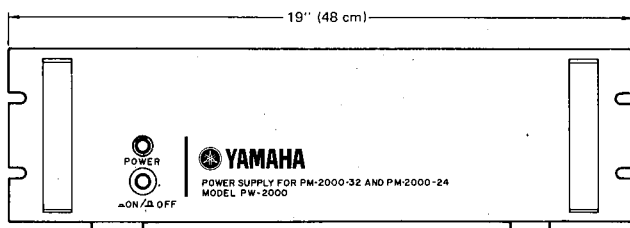

Weight
 33 pounds (15 kg)

APPLICATIONS

The following sound system diagrams illustrate just a few of the almost infinite setups for the PM-2000. We realize these diagrams are merely starting points; you will undoubtedly come up with a variety of setups that are best suited to your application. It should be remembered that all the various mixing controls and switch settings are just as important to the application as is the hookup diagram; refer to the "Mix Matrix Description" for additional background information.

The PM-2000's 32 input channels are fully occupied by microphone and line inputs from the stage. If additional inputs are required, smaller mixers or consoles such as the Yamaha PM-180, M-508, M512, M916 or M1516 may be used; their program outputs can be applied directly to the PM-2000's program sub inputs (which are designated in this diagram for use of an 8-track tape playback *after* the show).

This setup allows for simultaneous reinforcement (via the matrix outputs) and 8-track tape recording (via the program outputs). The foldback outputs are used to provide submixed feeds to the stage monitor console; this enables a smaller console with fewer inputs to be used on stage. In some instances the mics and lines are split on stage and fed to the stage monitor and main reinforcement consoles simultaneously; the submixed feeds shown here can avoid the splitting of low-level signals, thus improving signal-to-noise performance.

Compressor/limiters may be used to prevent excess levels and to protect speakers; they are shown here between the program interstage patch points. By employing a separate compressor for each of the program submixes, the audible effects of compression can be reduced because one loud passage need not "modulate" the level of the entire mix. Another compressor/limiter is used here to prevent excessive "slap" of the spring in the reverb; the digital delay line includes built-in compression circuitry so no additional signal processing is required. Rather than returning the echo and reverb to the effects inputs, they are split and returned to 4 of the 8 mix matrix channels via the aux inputs. This enables the reverb to be added to the main house left and right and the house fill left and right channels, while the other matrix outputs and the program bus outputs remain "dry" for recording and other functions where reverb and echo are not desired.

NOTE: Even if the house mix is monaural, providing two identical discrete mixes to left and right halves of the sound system yields redundant protection. Stereo cassette recordings for reference make it easier to discern the various instruments and vocals during later playback.

It would be possible to make a 16-track or 24-track tape recording of the concert by using the channel interstage patch outputs as direct channel outputs to the recorder; in that case one would use as little equalization as possible. Since these outputs are pre-fader, mixing adjustments during the show would not affect the record levels.

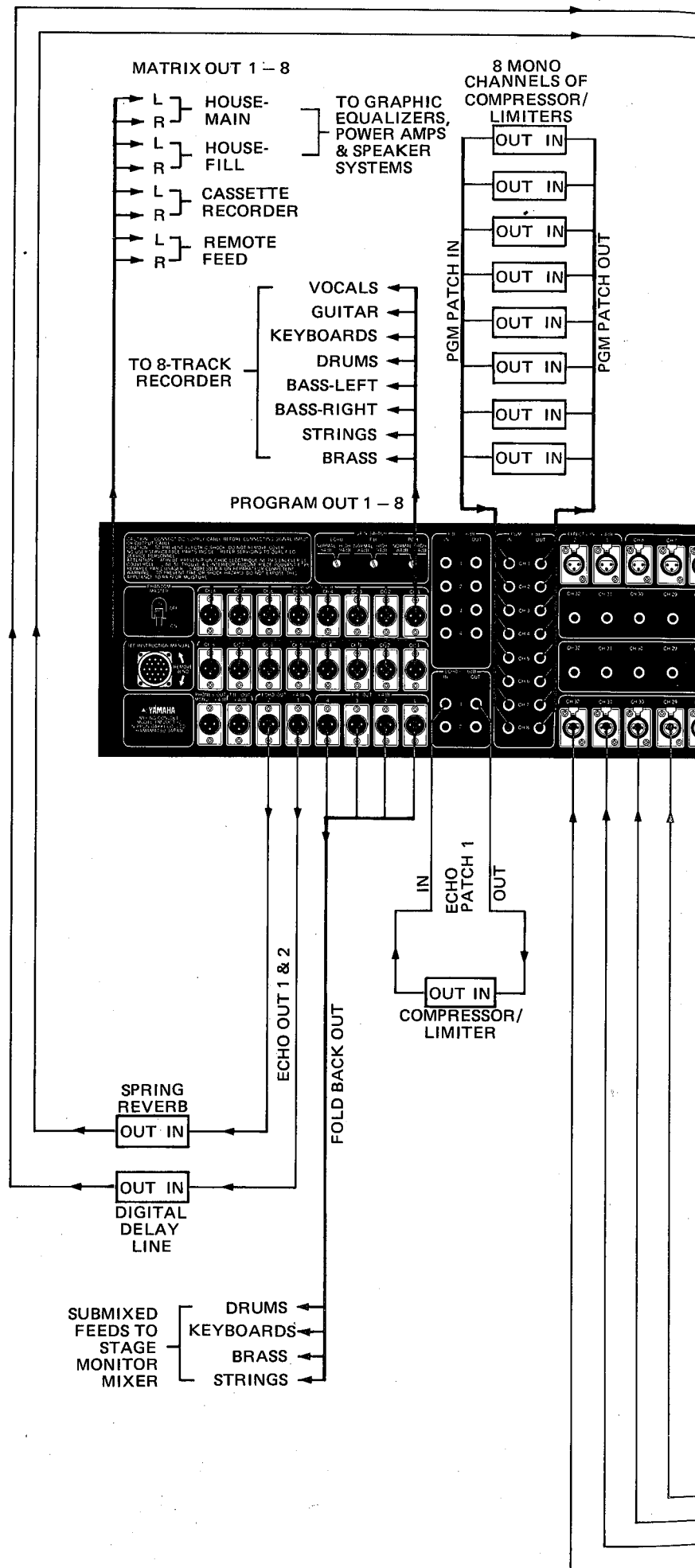

CONCERT SOUND REINFORCEMENT

A typical setup for the PM-2000-32 as the main mixing console.

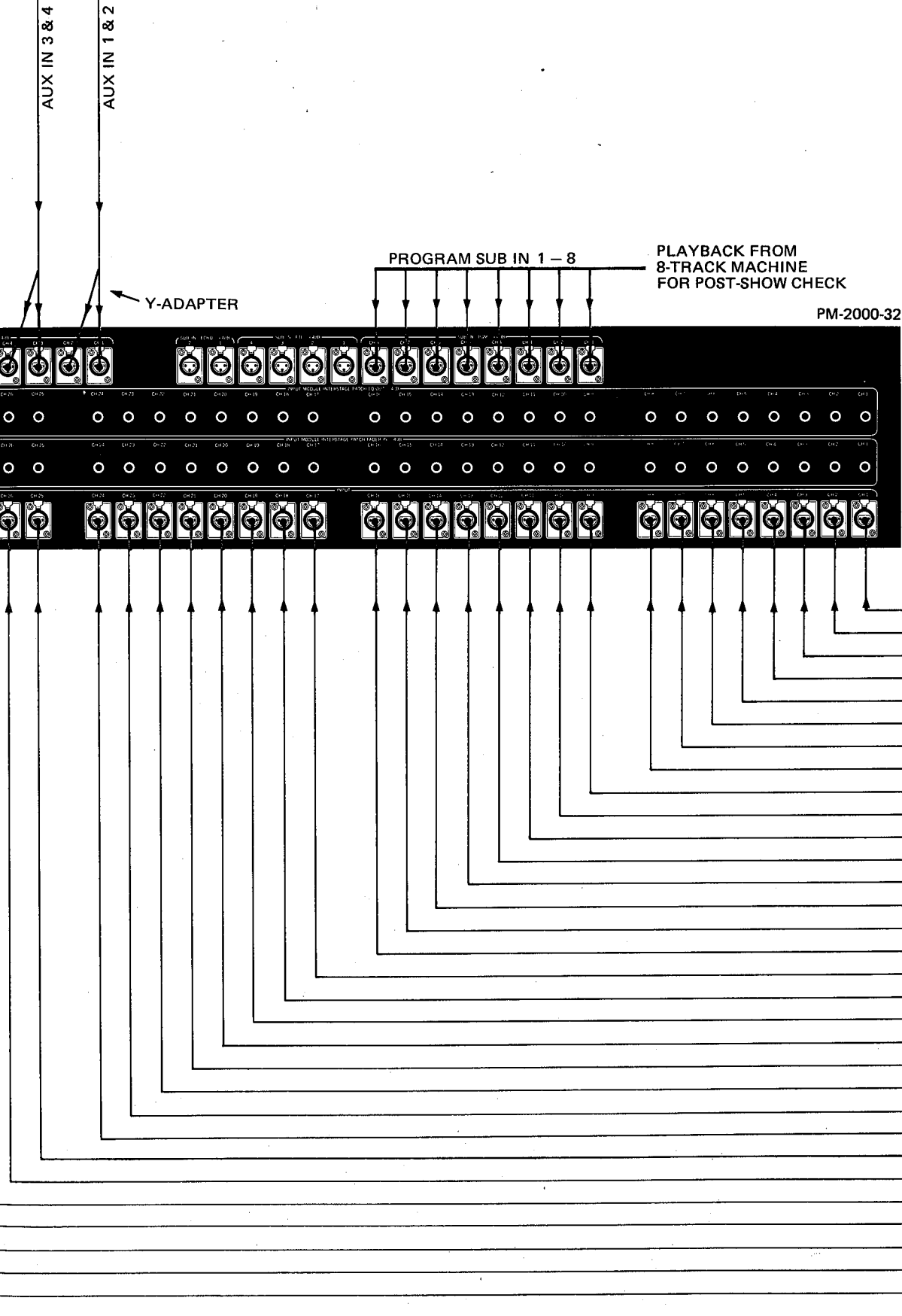

In this setup the input channels are almost fully occupied with one spare, and some of the input channel interstage patch points have been used to insert auxiliary equipment. The compressor/limiters on the lead vocal mics (channels 1 and 2) are used here in preference to compression at the program patch point; this prevents individual level variations by a given lead vocalist from having any effect on the mixed level of backup vocalists. (The backup vocalists, who sing in more carefully modulated tones, are compressed after being mixed, via the program interstage patch point. In addition to or instead of a compressor/limiter, one could use a digital delay line (one with internal direct/delay mixing) in the patch point to create vocal doubling effects.

A noise gate is used on the snare drum (channel 11); it is set to "turn off" the channel unless a very loud sound is present, thus avoiding leakage and sympathetic vibration from nearby drums and "tightening" the mix. A special type of noise gate (a keyable expander) is placed in the patch point for the kick drum (channel 12). The gate blocks the kick drum until a loud sound is present at its key input; the bass drum is connected to that key input, via the channel 13 interstage patch output. Thus, the kick drum is not heard unless the bass drum is also struck. This synchronizes the two drums even if the drummer was not quite in step. The bass drum signal does not actually pass through the noise gate, and because the PM-2000 interstage patch jacks are normalled, the bass drum can be heard whether or not the kick drum is played.

The lead guitar I input (channel 25) is set up here to yield a special effect (ring modulation) automatically whenever the guitarist plays hard; during average level playing the guitar is heard without the effect because the guitar signal always flows straight through input channel 25. The special effect is obtained only on loud passages by feeding the channel's interstage patch output through the ring modulator, then to a keyable expander. The expander's key input is triggered by a split from the same interstage output, and is set with a high threshold. When the guitarist plays loudly, the gate opens up and the ring modulation is fed to the PM-2000 effects input, where it is mixed into the program. One could use a phaser, fuzz box, flanger, etc. in place of the ring modulator. This gives some freedom to the busy soundman and the guitarist.

Not shown on this diagram, one or more stereo tape machines can be fed to a smaller mixer, such as the Yamaha PM-180, then brought into the Mix Matrix auxiliary inputs for background music during intermissions.

The rest of this setup is similar to the previous sound reinforcement diagram, although here the foldback busses are utilized to provide mixes for the lobby, dressing rooms, ticket areas, and so forth, and to provide a stereo cassette reference mix, while the program outputs are used as submixed feeds to the stage monitor console.

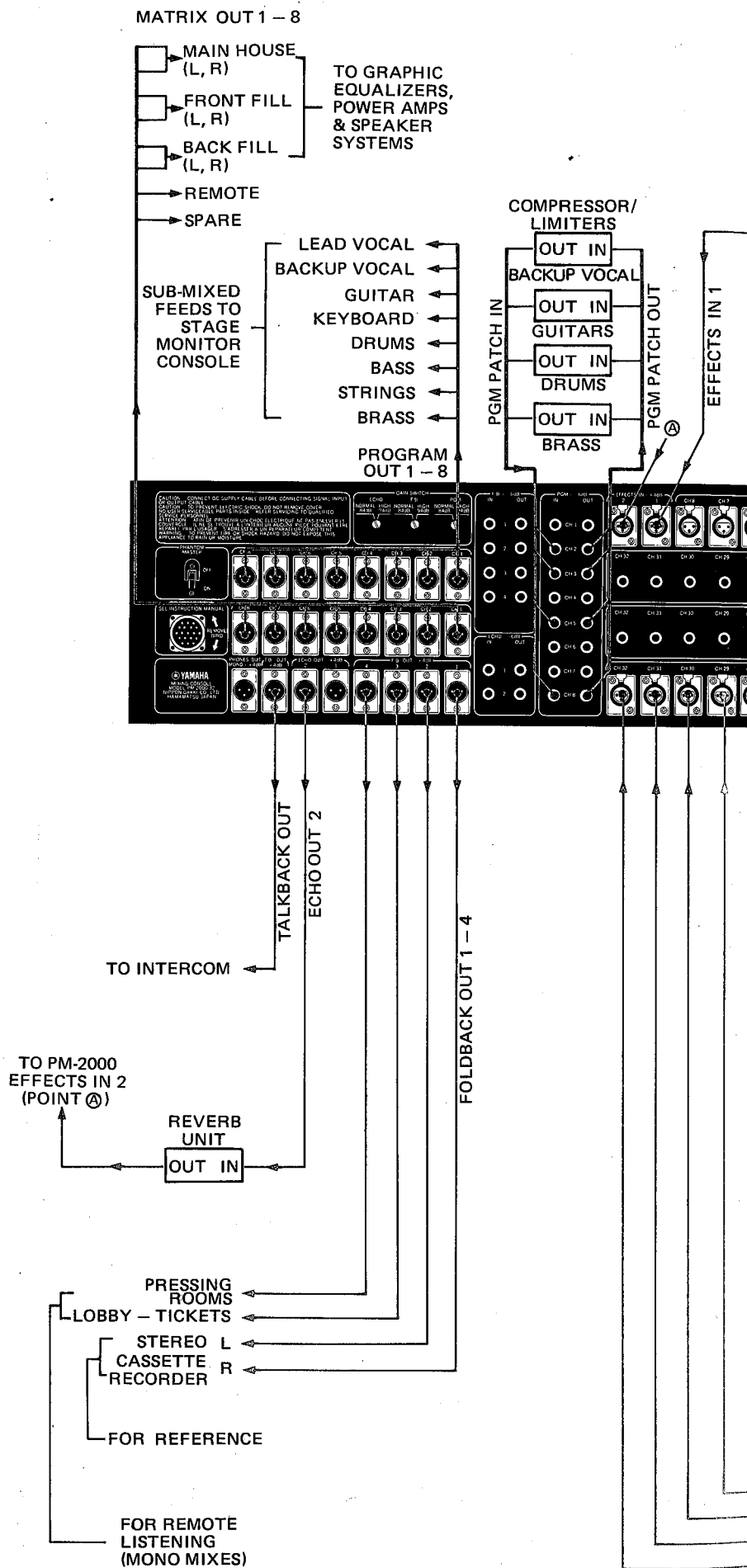

CONCERT SOUND REINFORCEMENT

A more elaborate setup for the PM-2000-32 as the main mixing console.

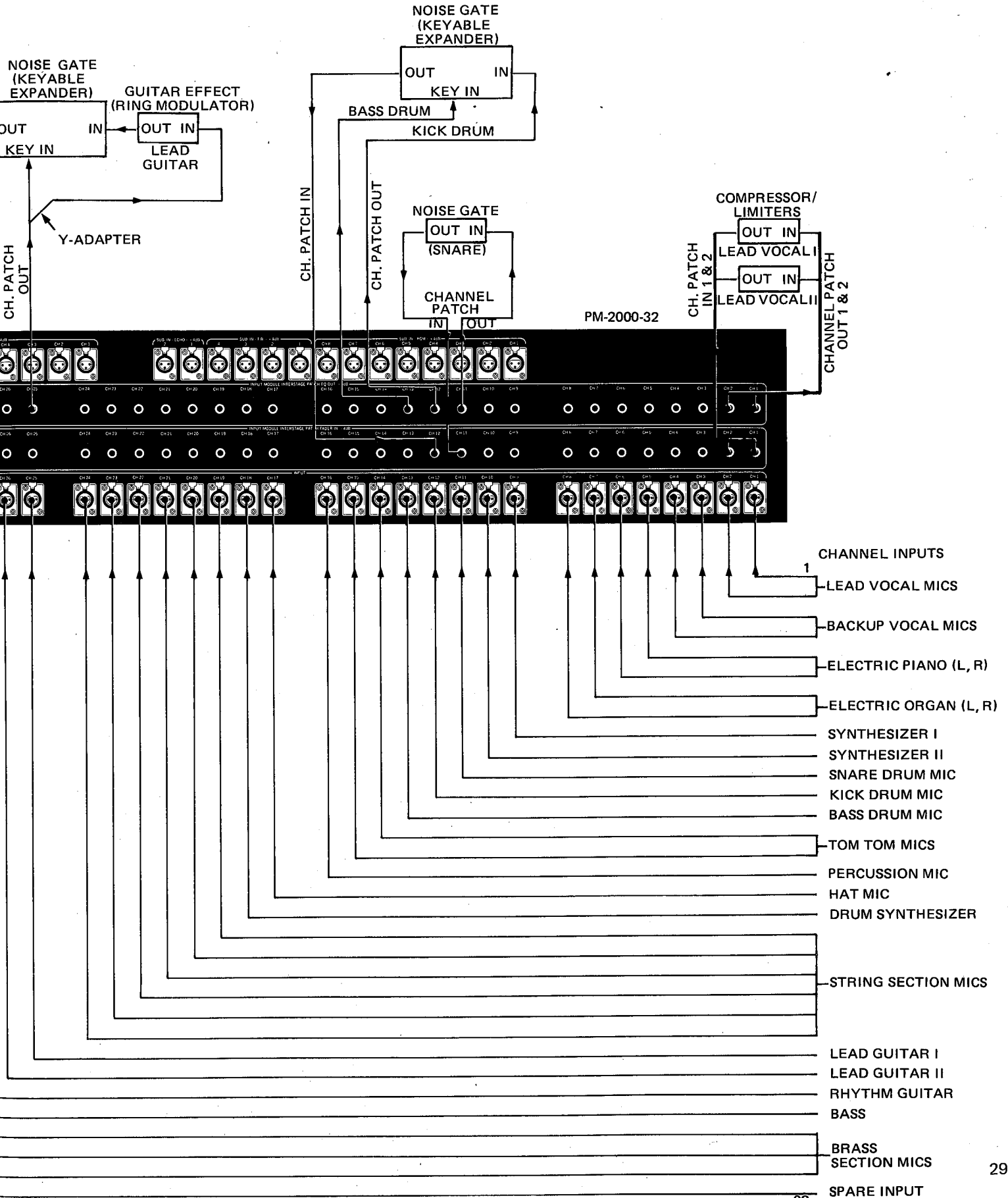

The channel inputs are the same variety of mics and lines fed to the main reinforcement console. These are taken from mic-level and line-level splitter boxes (multiple-secondary transformers) or from Y-adapters on instrument line outputs; the other splitter or "Y" outputs go to the main console. Submixed feeds for guitar, drums, strings and brass, are brought from the main house console to this console's program sub inputs (5 - 8), thus saving valuable input channel positions. Spring reverbs are connected in the echo send/effects return loop so that any inputs may be provided with reverb. Typically, the vocals and strings might want to hear the reverb in the monitors, even if the reverb is omitted from the main house mix.

The foldback outputs are used to form two dedicated stereo monitor feeds, one to the keyboard player and one to the lead vocalist's left and right stage monitors. Assignable feeds are provided by the Mix Matrix for the center vocal monitor, as well as the other stage monitors. While keyboard players often wish to submix their own instruments, this setup well may please the less technically oriented keyboard player.

The stage soundman may choose to listen with headphones, although he has the option of listening via an amplifier and monitor speaker which are fed from a mono mix of the headphones (via the rear panel phones output). The talkback output is fed to an intercom system. Before the show, the talkback line input (front panel) is used to play a mono tape which is assigned to the various mixing busses and aids in setting up the monitors when no players are present.

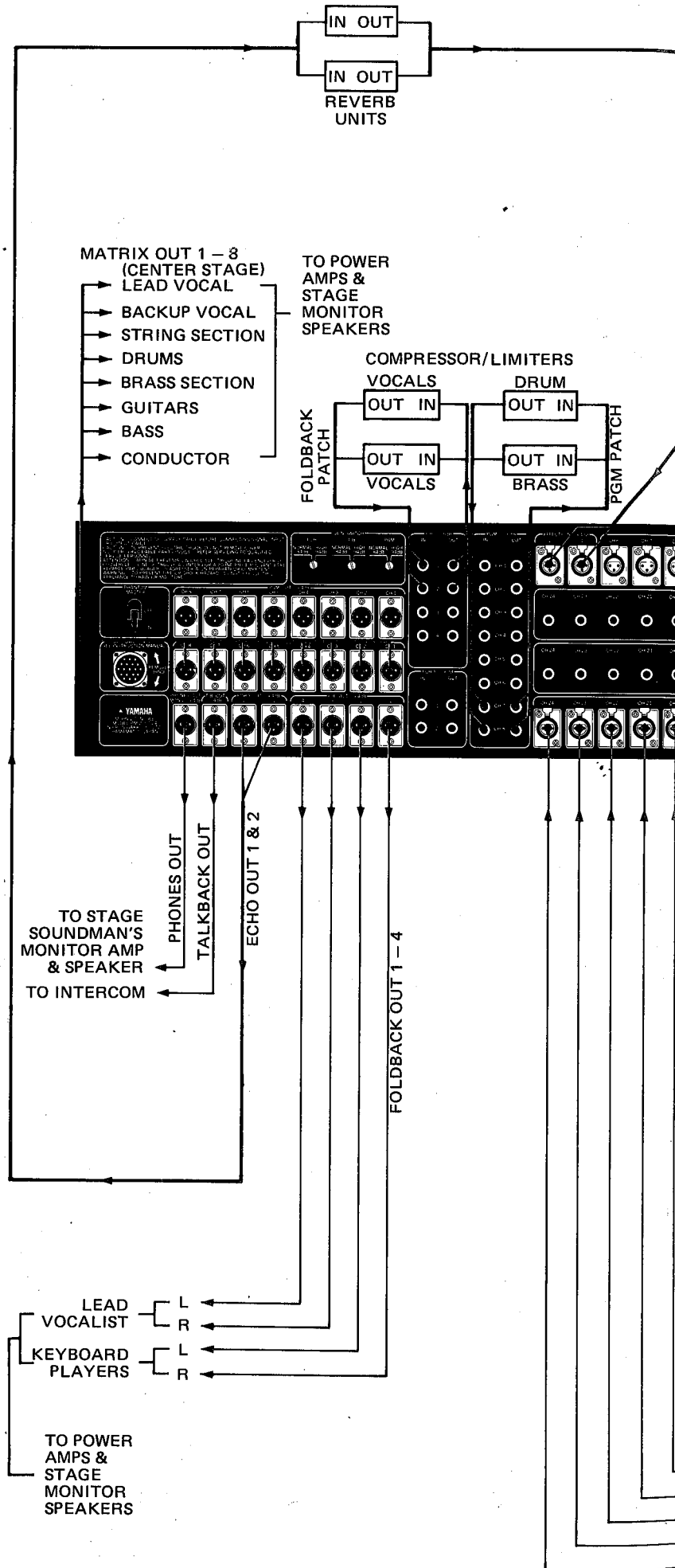

STAGE MONITORING

The PM-2000 is shown here dedicated to stage monitor mixing (24-channel version is shown arbitrarily; 32 inputs could be used).

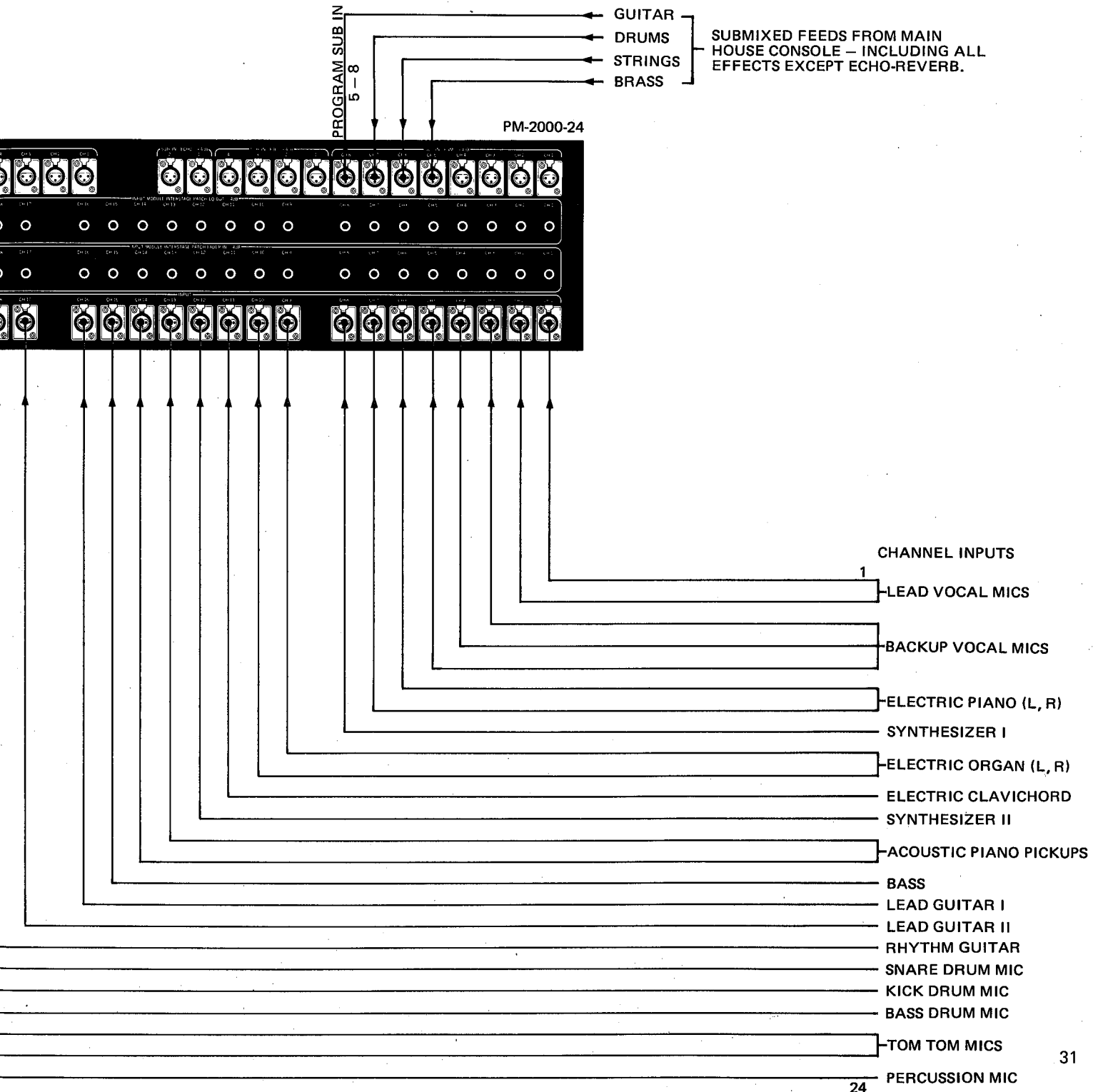

Input channels 1 through 8 are used for playback of a previously recorded 8-track tape of the show's orchestra. The balance of the inputs are used for live mics, additional live musical performance, remote inputs, and various tape cartridges for effects (i.e., applause) and bumpers (i.e., advertising sequés). This particular setup assumes a quiz show with two pair of contestant-guest opponents.

The guest star-contestant partners are physically and acoustically isolated for part of the show; then they must hear some of the production, but not other parts. This "mix-minus" monitoring is provided via the PM-2000 Mix Matrix and an interruptible foldback intercom system. Similarly, the emcee & camera operators require an interruptible foldback feed with a different mix, also provided by the mix matrix. The entire show is mixed together in other matrix channels for feed to the video tape recorder, and a backup mix is provided for emergency use.

The foldback outputs are used to feed mixes to the stage (stage mics mixed low to prevent feedback) and to the audience (stage mics higher in the mix). In more complex productions there may be a separate mixer specifically for audience and stage foldback, and the PM-2000 foldback outputs could provide submixed feeds to that house mixer. The S.A. (stage announce) speakers or intercom can be fed from the console's T.B. output.

The program outputs are not used during the show, but are used prior to the show for feeding the 8-track tape recorder. At this time the unused announcer, contestant and other inputs may be used for orchestra mics.

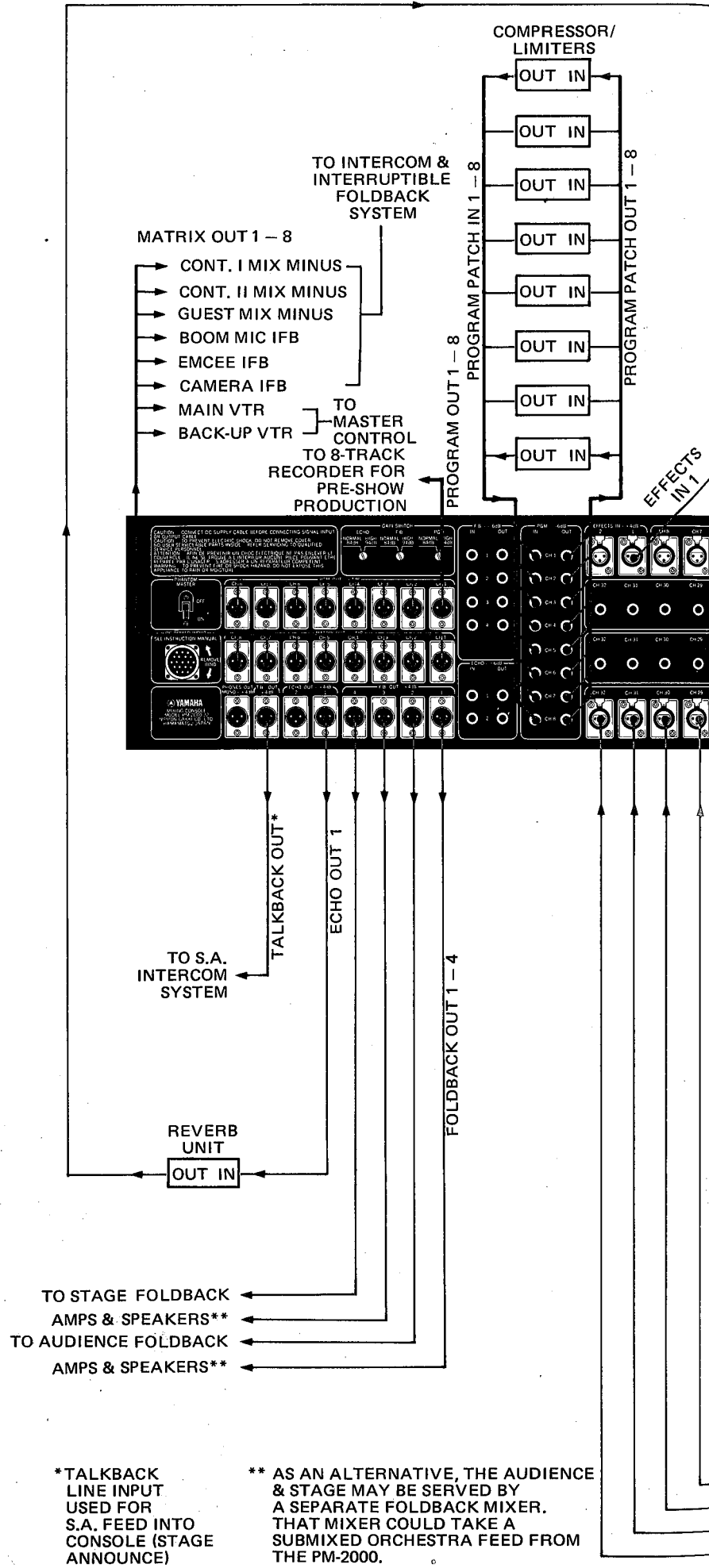

*TALKBACK LINE INPUT USED FOR S.A. FEED INTO CONSOLE (STAGE ANNOUNCE)

** AS AN ALTERNATIVE, THE AUDIENCE & STAGE MAY BE SERVED BY A SEPARATE FOLDBACK MIXER. THAT MIXER COULD TAKE A SUBMIXED ORCHESTRA FEED FROM THE PM-2000.

TELEVISION SHOW PRODUCTION

A typical setup for pre-production recording and live (or taped) show production in the studio.

PM-2000-32

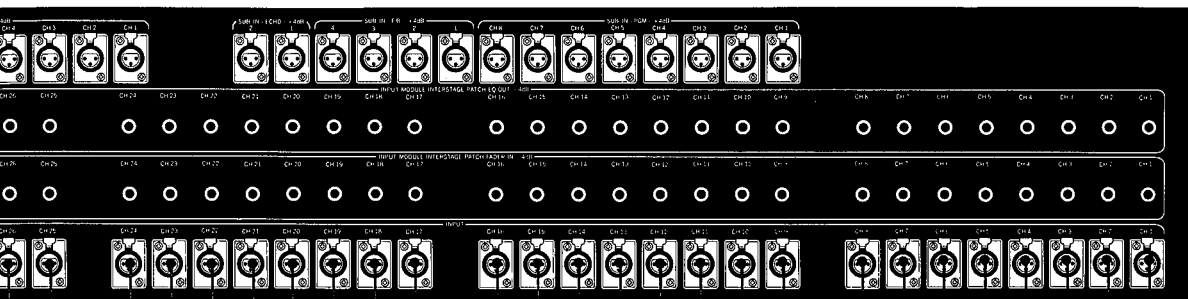

FOR PRE-SHOW PRODUCTION
— USE FOR ADDITIONAL ORCHESTRA MICS

CHANNEL INPUTS

PRE-RECORDED ORCHESTRA FROM 8-TRACK TAPE MACHINE

ANNOUNCER
EMCEE
CONTESTANT I
CONTESTANT II
GUEST STAR I
GUEST STAR II

"LIVE" MICS

BOOM
AUDIENCE
AUDIENCE
CART MACHINE — BUMPERS
CART MACHINE — EFFECTS/SWEETENING
CART MACHINE — EFFECTS/SWEETENING

REMOTE FEED
REMOTE FEED
SPARE MIC
SPARE MIC
PIANO MIC
ELECTRIC GUITAR
BASS
DRUM
HORNS
STRINGS

"LIVE" ORCHESTRA BACK-UP MICS

VTR PLAYBACK
EFFECTS AUDIO (BUZZER)

The PM-2000 would be "at home" in a remote truck which is covering a track and field meet. Two radio mics are brought to input channels 1 and 2 for use with any event. Noise gates may be inserted in these channels' interstage patch points, creating a "squelch" circuit that automatically mutes the inputs unless sustained speech is present.

Separate crews cover each of three events, so there are three reporter mic inputs, two boom mics, and there are inputs for background music from the stadium's sound system; such music might accompany gymnastics, half-time shows, etc. Live mics are provided for a "parade", half-time show, or similar event. In addition, there are audio inputs from the 5 video tape recorders to be used for pre- or post- production monitoring, for certain types of "live" instant playback, and so forth. Four channels are designated for playback of pre-recorded music, such as the show theme or school alma mater.

The remote inputs might come from the studio, via TelCo (telephone company) lines or microwave transmission, and their audio response would not match that of the local mics; therefore graphic equalizers are inserted in these channels' interstage patch points.

The optional bank of compressor/limiters shown here keeps average modulation high while preventing overmodulation; by compressing the components of the mix rather than fully mixed program outputs these compressor/limiters introduce less audible distortion and lessen the compression and limiting required at the transmission point.

The matrix outputs provide five discrete mixes for audio to the VTR's, as well as primary and secondary outputs to transmission. A spare matrix output is used to make a reference audio cassette tape.

The echo outputs are assigned for IFB (interruptible foldback) feeds to the two boom mic operators, enabling them to hear what their mic is doing. The foldback outputs provide IFB monitoring for the three reporters and the announcer. In this way the PM-2000 does the job of three consoles at once.

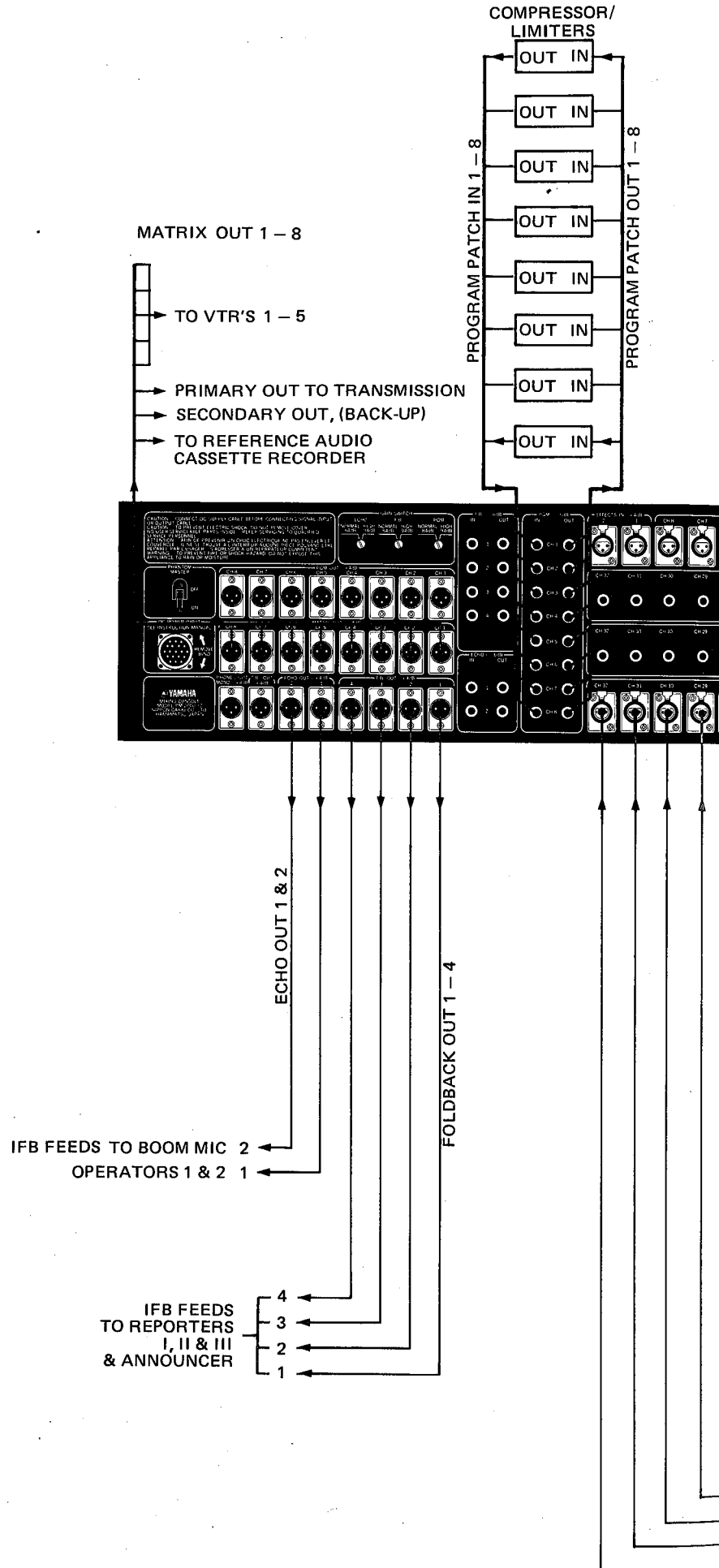

TELEVISION REMOTE PRODUCTION

A setup for complex sports coverage with three simultaneous events.

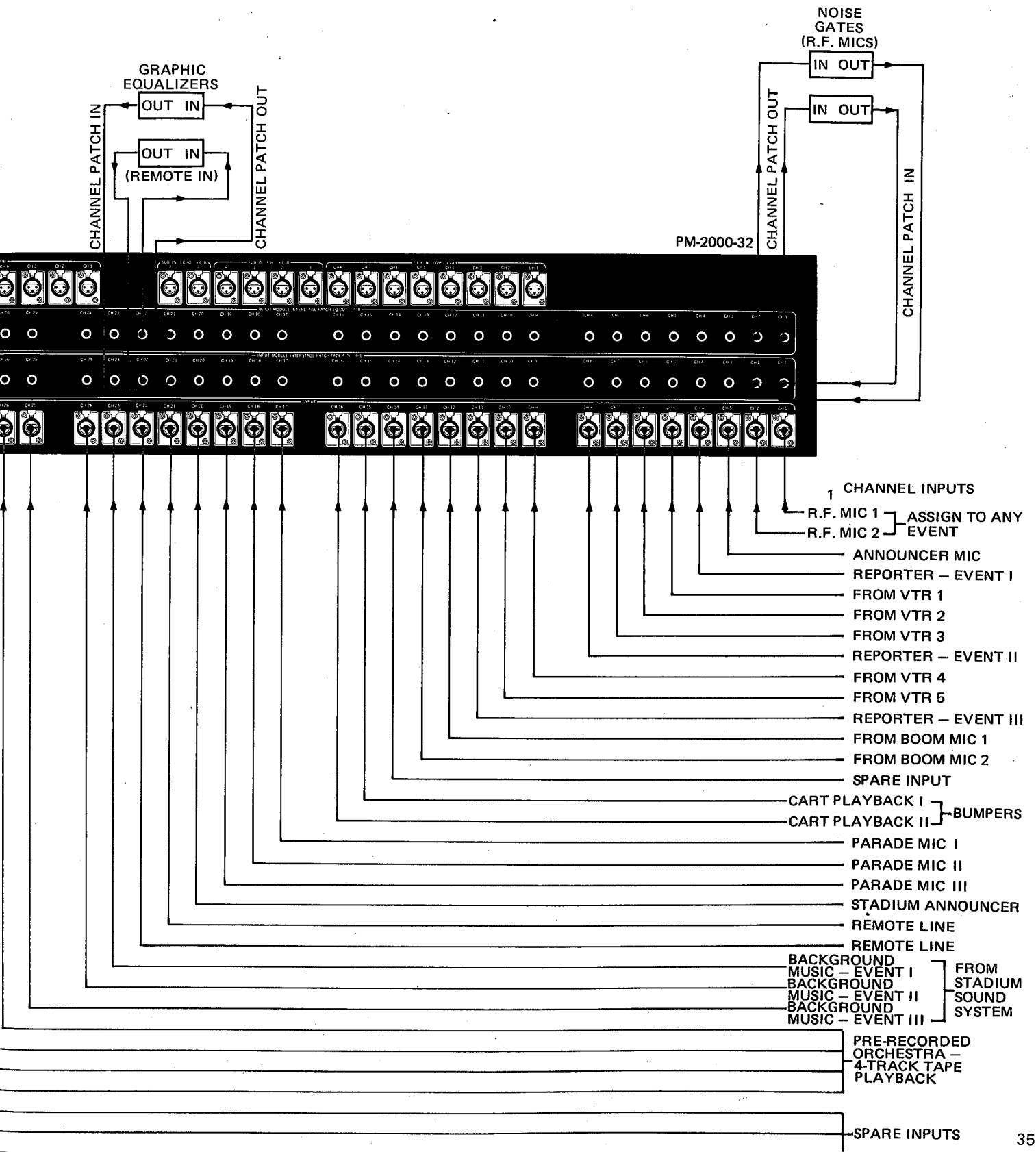

This setup is tailored to a play, although few changes would be required for a musical show: perhaps more live mics and less tape playback, and a few additional monitor speakers.

The 4-track and stereo tape playback are used for previously recorded music and special effects. Any recorded music may be interspersed with live music, if desired; present day tape noise reduction systems and medium cost tape machines make it possible to have recordings that cannot be readily discerned from live performances.

The inputs are assigned to the program busses in such a way as to make each bus carry a different "scene." The mix matrix is then utilized to remix the various scenes into the desired areas of the sound system: stage left, center and right, audience fill left and right, or some specially placed speakers. At the cue for each scene, the appropriate inputs could be made "live" by bringing up the master faders, but a more accurate method is to preset the masters and turn on the designated master program on/off switch. More than one scene may be "on" at once, and the master faders also may be used for cross-fading between scenes.

Graphic equalizers are inserted in the program interstage patch points for a couple of "scenes," thus enabling the frequency response to be carefully manipulated for optimum effect; some delay or reverb could be assigned to specific scenes, i.e., to specific program busses (via the effects returns) to alter the spatial imagery of the sound. For this reason, a stereo reverb or delay unit is shown connected between the echo send outputs and the effects inputs.

The foldback outputs are utilized for creating a mono mix which is fed to peripheral areas, including dressing rooms, the lighting booth, lobby, etc. A stereo foldback mix is useful for feed to a recorder or for a remote broadcast. Alternatively one of the Mix Matrix outputs could be used as a mono broadcast feed with the advantage of automatic scene switching (which is not available in the foldback outputs). Foldback may also be used to feed monitors for any live musicians or off-stage performers.

Notice that the same mono feed provided for peripheral areas (foldback 1) also is fed to a mono cassette machine for a reference recording; the take-off point is at the foldback interstage patch output. This does not interrupt signal flow and it avoids the need for a Y-adaptor cable.

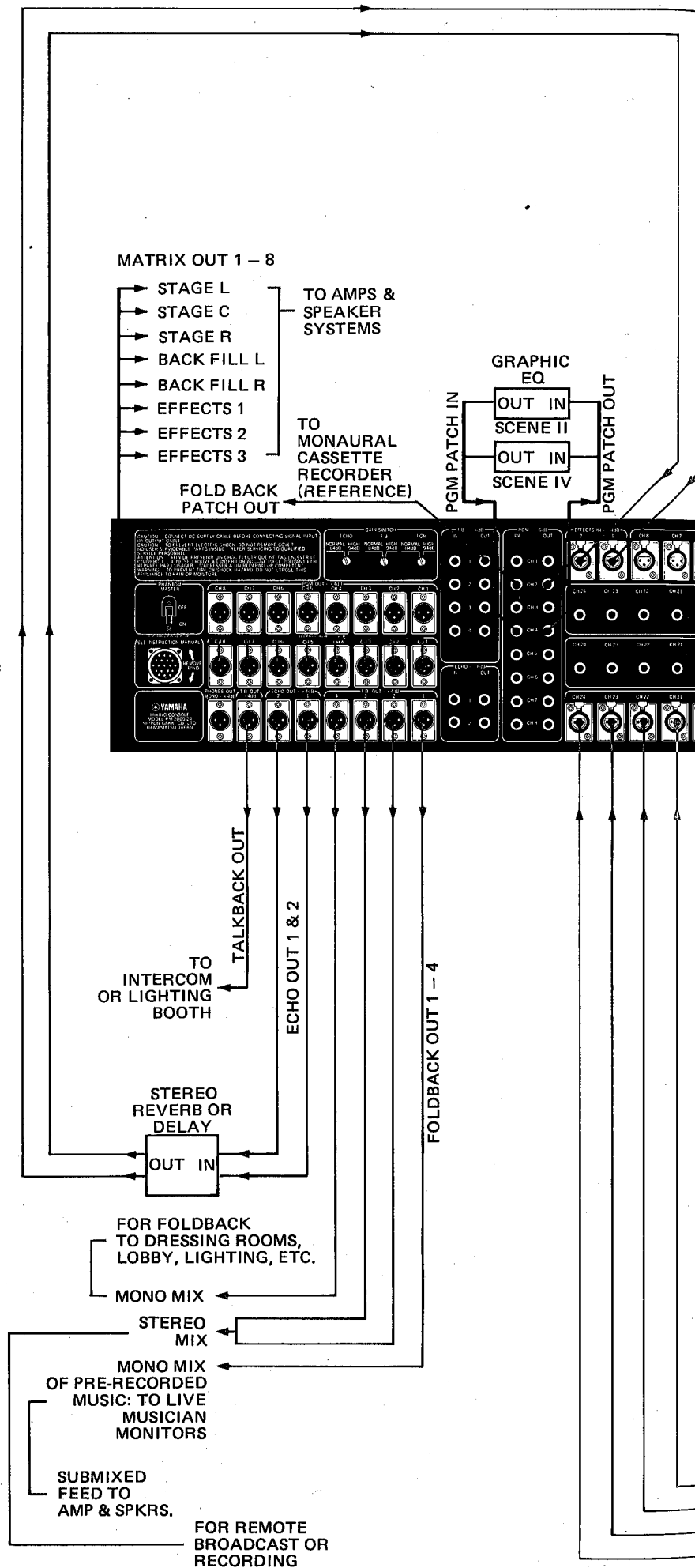

THEATRICAL PRODUCTION

A typical setup for reinforcement and special effects in a live play or musical show (24 channel PM-2000 shown here).

PM-2000-24

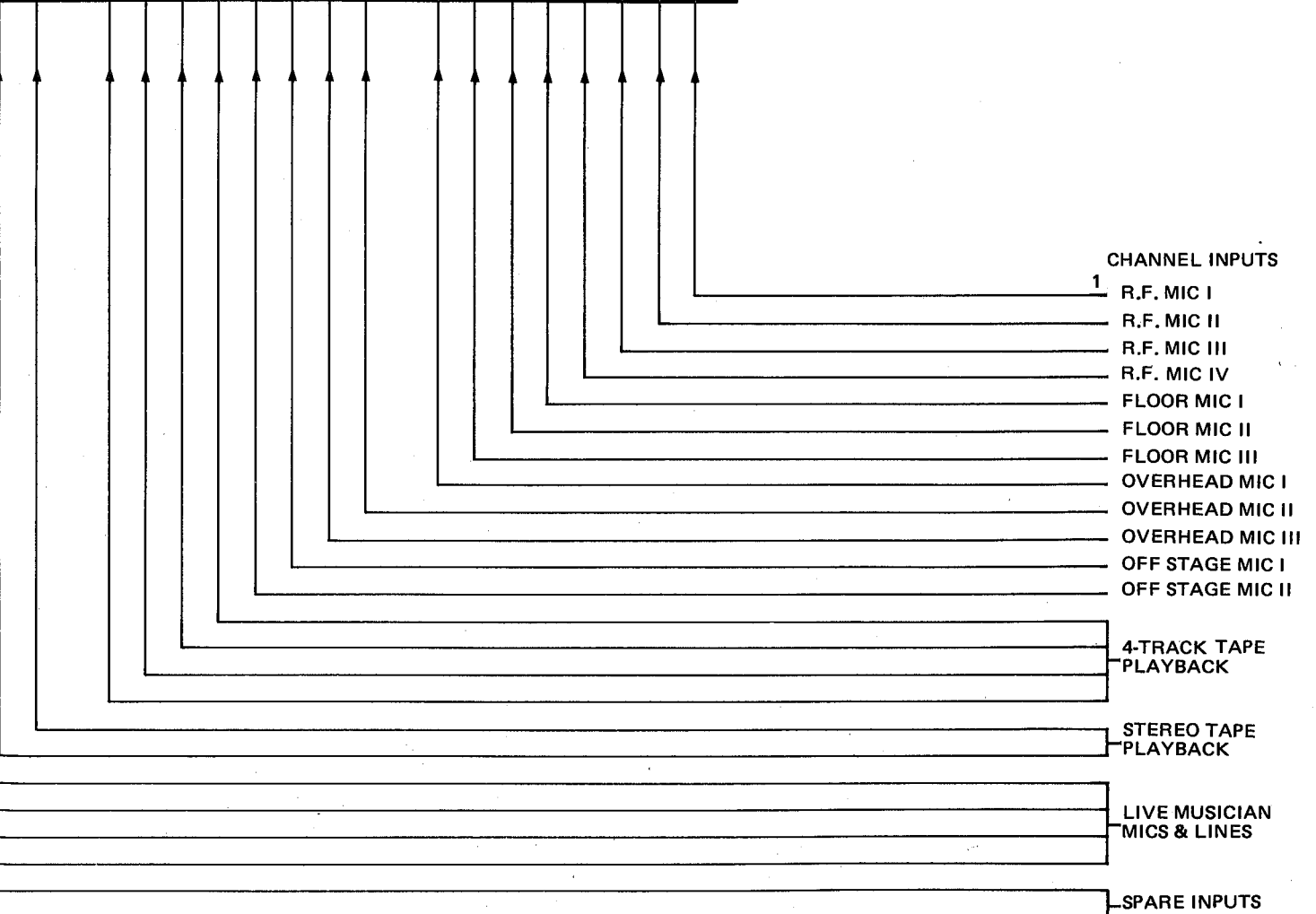
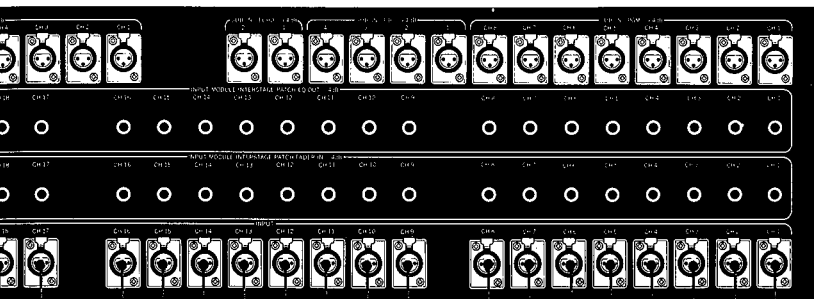

CHANNEL INPUTS

- 1 R.F. MIC I
- R.F. MIC II
- R.F. MIC III
- R.F. MIC IV
- FLOOR MIC I
- FLOOR MIC II
- FLOOR MIC III
- OVERHEAD MIC I
- OVERHEAD MIC II
- OVERHEAD MIC III
- OFF STAGE MIC I
- OFF STAGE MIC II
- 4-TRACK TAPE PLAYBACK
- STEREO TAPE PLAYBACK
- LIVE MUSICIAN MICS & LINES
- SPARE INPUTS

This setup is somewhat of a hybrid, and it shows how the PM-2000 might be used for several aspects of studio (or remote) recording. If a large number of mics and lines were being used at once to do a 24-track or 32-track recording, these sources could be applied to the PM-2000 channel inputs, and the channel interstage patch outputs would then be connected directly to the tape machine. Usually fewer than 24-tracks are recorded at a given time, so the direct output would not be necessary.

An 8-track recording could be made directly from the program outputs, which would be submixed from any number of channel inputs. In fact, 16- or 24-track recordings could also be built up in groups of 8 using the program outputs, assigned to different recorder inputs.

In any case, once the multi-track tape is obtained, it may be mixed down to mono, stereo and/or quad by applying the tape playback to the console's channel inputs. These signals may be panned left-right across any odd to even numbered program busses, using the input module's built-in panning facilities. Program busses could then be set up for stereo perspectives. As an alternative, the multiple input channels could be mixed down into various subgroups of instruments and vocals. The Master Faders then afford the opportunity to balance the mix. The stereo perspective is obtained in the Mix Matrix, which in turn feeds the stereo and/or quad tape machines. One matrix channel may also be used to make a mono recording, or the headphone cue system may be used for a mono compatibility check.

Additional matrix channels may be used to provide headphone cue mixes for performers who wish to record along with (or on top of) existing tracks - to overdub. The foldback outputs are used to mix two stereo pairs, one for control room and one for studio monitor speakers.

One echo output feeds a reverb and the other a delay line; the output of these devices is brought back to the console via the effects inputs. However, it is sometimes desirable to first run the sound through the delay and then through the reverb; this can be done as shown, utilizing a splitter or Y-adaptor cable and a spare input channel.

A compressor/limiter and a parametric (or graphic) equalizer are shown here as they would be used for individual input channels. Graphic or parametric equalizers also might be used to tailor the sound of each of the sub groups, accessible via the program interstage patch points.

The Talkback mic can be assigned to the foldback 3 & 4 busses for conversation into the studio; alternatively, the talkback output can be run to a separate amp and speaker in the control room, lessening the chance for the wrong assignment button to be engaged (foldback 1 or 2), which will lead to unwanted feedback.

While few recording consoles would be usable for sound reinforcement, the PM-2000 is an excellent reinforcement console that is flexible enough to be used for recording. With some thought as to setup and mixing techniques, the console may be used for simultaneous reinforcement and recording, thus providing considerable savings to the group who wishes to record a concert tour, for the stage show needing a reference recording, and so forth.

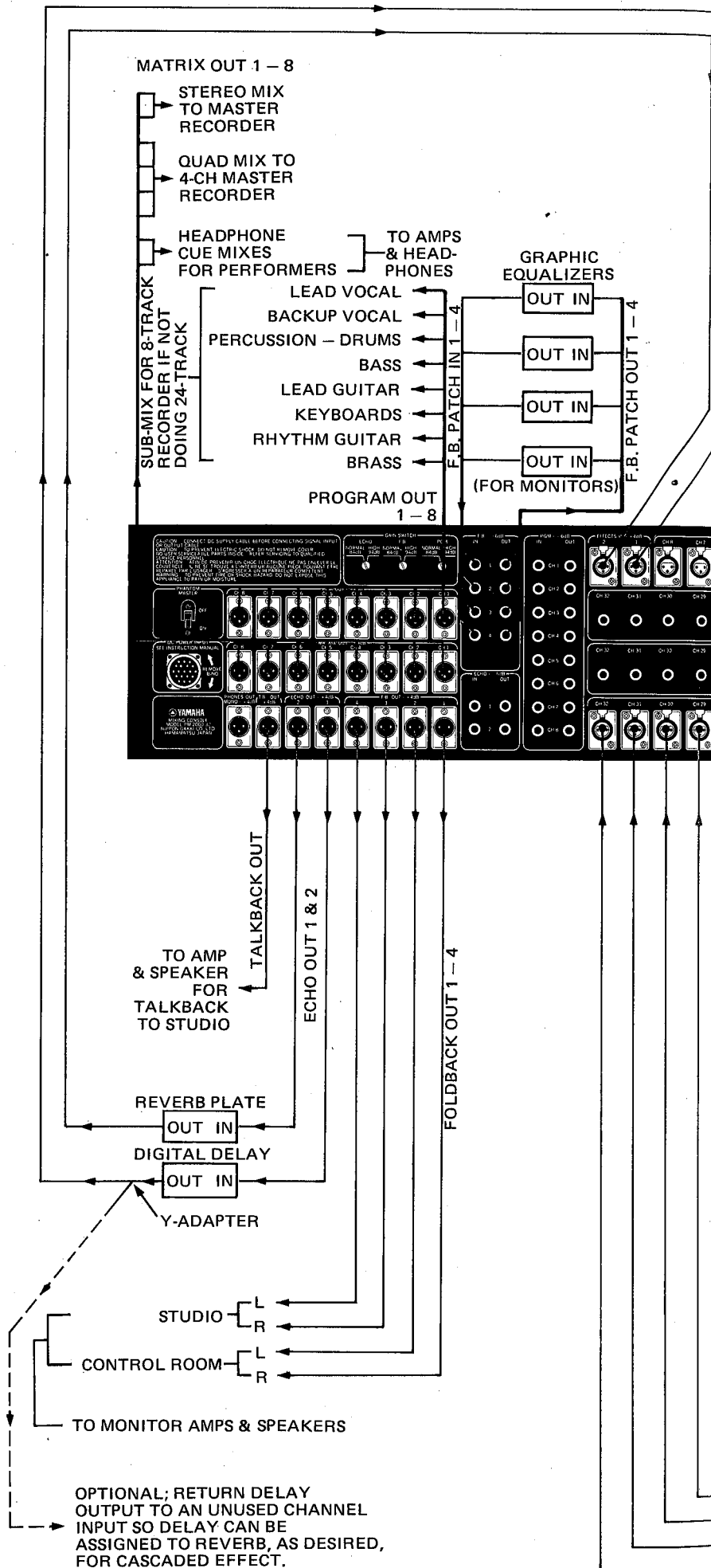

RECORDING & MIXDOWN

The PM-2000 is sufficiently flexible to be used for original multi-track recording, mixdown to stereo or quad, and overdubbing.

(TYPICAL USE FOR SELECTED INPUT CHANNELS)

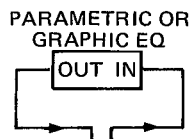

(TYPICAL USE FOR SELECTED INPUT CHANNELS)

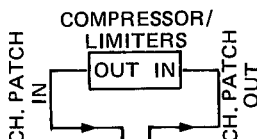

THESE JACKS CAN BE USED AS DIRECT OUTPUTS TO MULTI-TRACK RECORDER DURING ORIGINAL RECORDING SESSION: SET LEVELS WITH INPUT LEVEL SWITCHES.

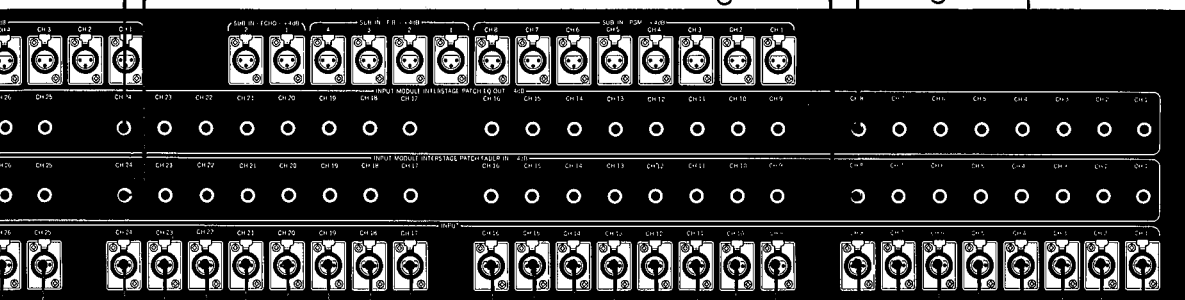

PM-2000-32

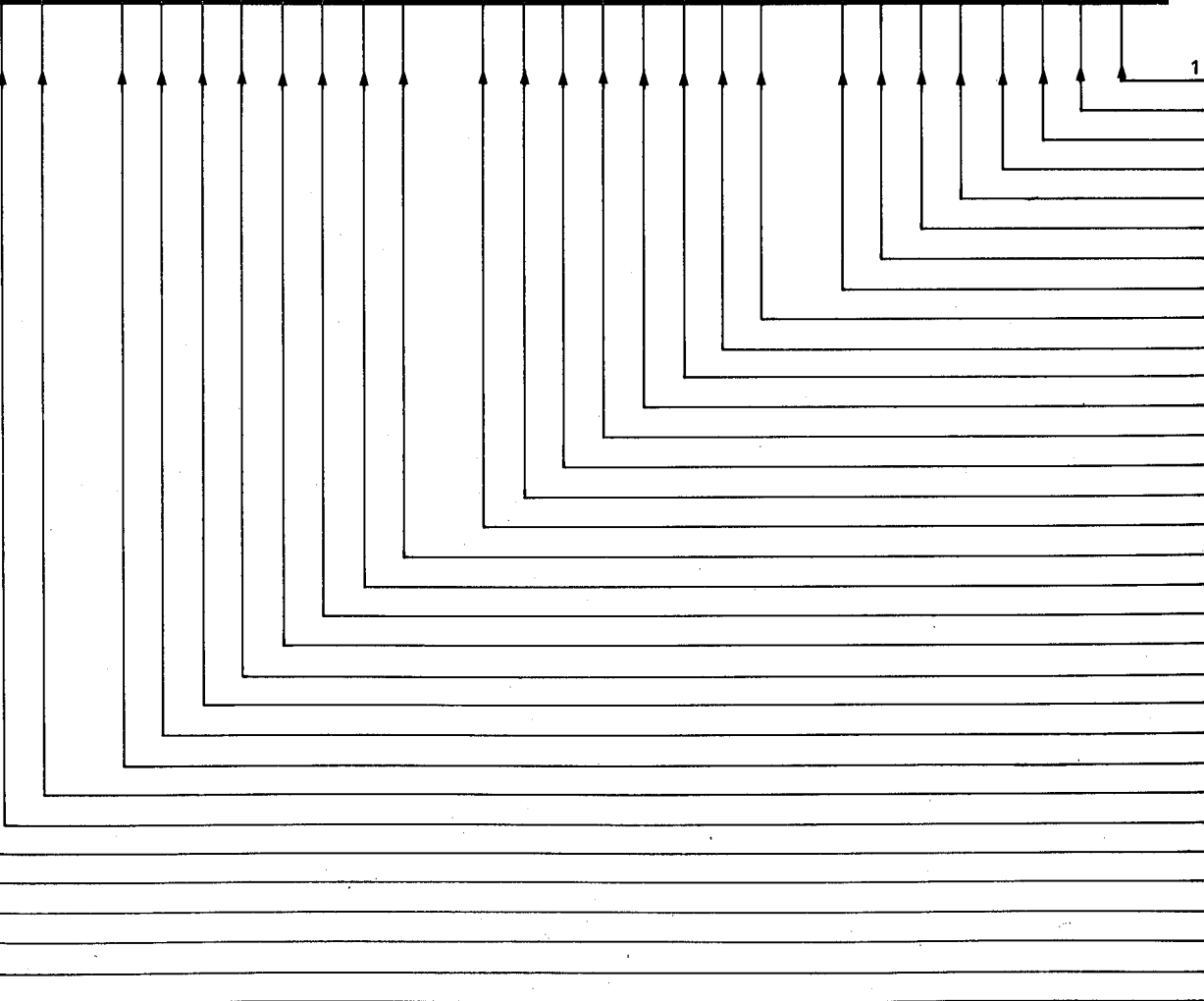

CHANNEL INPUTS

CH1 - 24:
LIVE STUDIO
MICS & LINES
OR
24-TRACK
TAPE PLAYBACK
FOR MIXDOWN
TO 8, 4, 2 or 1
CHANNEL

CH25 - 32:
LIVE MICS &
LINES FOR
OVERDUB
DURING 24-TRACK
PLAYBACK
OR
FOR 8-TRACK
PLAYBACK &
MIXDOWN

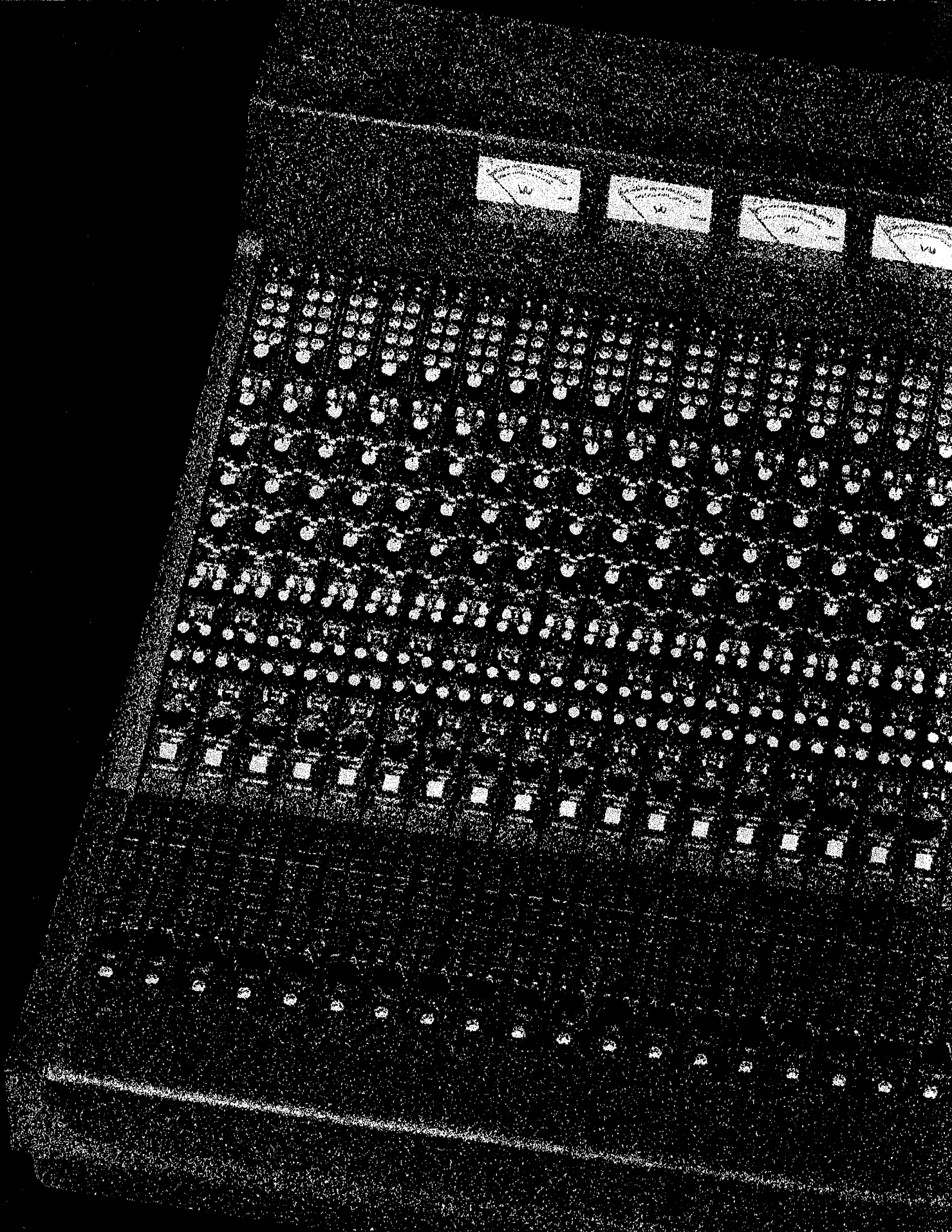

SINCE 1887



YAMAHA

NIPPON GAKKI CO., LTD. HAMAMATSU, JAPAN