

YAMAHA

SPX990

Professional Multi-effect Processor
Processeur Multi-effets Professionel
Professioneller Multieffekt-Prozessor

Operation Manual
Manuel D'utilisation
Bedienungsanleitung

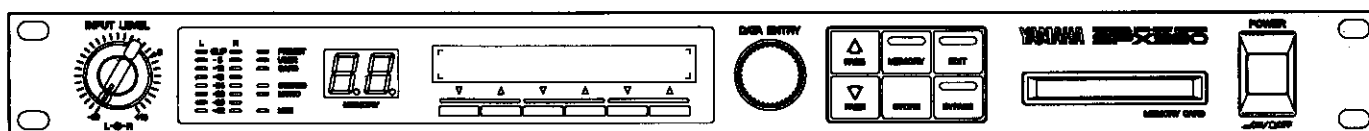

FCC INFORMATION (U.S.A.)

1. IMPORTANT NOTICE: DO NOT MODIFY THIS UNIT!

This product, when installed as indicated in the instructions contained in this manual, meets FCC requirements. Modifications not expressly approved by Yamaha may void your authority, granted by the FCC, to use the product.

2. IMPORTANT: When connecting this product to accessories and/or another product use only high quality shielded cables. Cable/s supplied with this product MUST be used. Follow all installation instructions. Failure to follow instructions could void your FCC authorization to use this product in the USA.

3. NOTE: This product has been tested and found to comply with the requirements listed in FCC Regulations, Part 15 for Class "B" digital devices. Compliance with these requirements provides a reasonable level of assurance that your use of this product in a residential environment will not result in harmful interference with other electronic devices. This equipment generates/uses radio frequencies and, if not installed and used according to the instructions found in the users manual, may cause interference harmful to the operation of other electronic devices. Compliance with FCC regulations does not guarantee that interference will not occur in all installations. If this product is found to be the source of interference, which can be determined by turning the unit "OFF" and "ON", please try to eliminate the problem by using one of the following measures:

Relocate either this product or the device that is being affected by the interference.

Utilize power outlets that are on different branch (circuit breaker or fuse) circuits or install AC line filter/s.

In the case of radio or TV interference, relocate/reorient the antenna. If the antenna lead-in is 300 ohm ribbon lead, change the lead-in to co-axial type cable.

If these corrective measures do not produce satisfactory results, please contact the local retailer authorized to distribute this type of product. If you can not locate the appropriate retailer, please contact Yamaha Corporation of America, Electronic Service Division, 6600 Orangethorpe Ave, Buena Park, CA 90620. The above statements apply ONLY to those products distributed by Yamaha Corporation of America or its subsidiaries.

- * This applies only to products distributed by Yamaha Corporation of America.
- * Dies bezieht sich nur auf die von der Yamaha Corporation of America vertriebenen Produkte.
- * Ceci ne s'applique qu'aux produits distribués par Yamaha Corporation of America.
- * Esto se aplica solamente a productos distribuidos por Yamaha Corporation of America.

IMPORTANT NOTICE FOR THE UNITED KINGDOM

Connecting the Plug and Cord

WARNING : THIS APPARATUS MUST BE EARTHED

IMPORTANT. The wires in this mains lead are coloured in accordance with the following code:

GREEN-AND-YELLOW	:	EARTH
BLUE	:	NEUTRAL
BROWN	:	LIVE

As the colours of the wires in the mains lead of this apparatus may not correspond with the coloured markings identifying the terminals in your plug proceed as follows:

The wire which is coloured GREEN-AND-YELLOW must be connected to the terminal in the plug which is marked by the letter E or by the safety earth symbol  or coloured GREEN or GREEN-AND-YELLOW.

The wire which is coloured BLUE must be connected to the terminal which is marked with the letter N or coloured BLACK.

The wire which is coloured BROWN must be connected to the terminal which is marked with the letter L or coloured RED.

- * This applies only to products distributed by YAMAHA - KEMBLE MUSIC (U.K.) LTD.

CANADA

THIS DIGITAL APPARATUS DOES NOT EXCEED THE "CLASS B" LIMITS FOR RADIO NOISE EMISSIONS FROM DIGITAL APPARATUS SET OUT IN THE RADIO INTERFERENCE REGULATION OF THE CANADIAN DEPARTMENT OF COMMUNICATIONS.

LE PRESENT APPAREIL NUMERIQUE N'EMET PAS DE BRUITS RADIOELECTRIQUES DEPASSANT LES LIMITES APPLICABLES AUX APPAREILS NUMERIQUES DE LA "CLASSE B" PRESCRITES DANS LE REGLEMENT SUR LE BROUILLAGE RADIOELECTRIQUE EDICTE PAR LE MINISTERE DES COMMUNICATIONS DU CANADA.

- * This applies only to products distributed by Yamaha Canada Music Ltd.
- * Dies bezieht sich nur auf die von der Yamaha Canada Music Ltd vertriebenen Produkte.
- * Ceci ne s'applique qu'aux produits distribués par Yamaha Canada Music Ltd.
- * Esto se aplica solamente a productos distribuidos por Yamaha Canada Music Ltd.

Litiumbatteri!

Bör endast bytas av servicepersonal.
Explosionsfara vid felaktig hantering.

VAROITUS!

Lithiumparisto, Räjähdyksvaara.
Pariston saa vaihtaa ainoastaan alan ammattimies.

ADVARSEL!

Lithiumbatteri!
Ekspløsningsfare. Udskiftning må kun foretages af en sagkyndig, - og som beskrevet i servicemanualen.

SPX990 FEATURES

- 20 bit A/D and D/A conversion for high quality sound.
- pre/post-effects in a high quality Multi-effect system.
- with memory card slot, XLR-type connectors and phone jacks
- convenient operations using function keys, data entry dial and large LCD display panel.

Congratulations on your acquisition of a Yamaha SPX990 Professional Multi-effect Processor. The SPX990 offers 80 preset effect programs including accurate simulations of natural reverb and early reflections, delay and echo effects, modulation effects, pitch change effects, complex effects, freeze (sampling) programs which can do loop playback and much more. Epoch-making new effects like the main effect programs include multi-tap delay for accurate definition of time and pan of several delays, round pan and intelligent pitch which can add harmony through internal recording on specific keys and scales. The temp. mono echo, temp. stereo echo, and temp. quad echo effects also add new attractive features to the SPX990. With a sampling frequency of 44.1kHz, it delivers a full, flat frequency response from 20Hz to 20kHz for exceptionally clean, "transparent" effect sounds and direct digital interfacing capabilities making it compatible with the most up-to-date sound systems. The preset effect programs can be edited, re-titled and stored in any of the 100 RAM memory locations. Convenient external data storage is provided by a memory card slot that accepts optional RAM cards for storage effect programs. The 3-band parametric EQ, compressor, Aural Exciter®, or distortion can be used in the pre-effect program for precise tonal tailoring. The 3-band parametric EQ, compressor, or Aural Exciter® can also be used in the post-effect program. The SPX990 is also MIDI compatible, with a MIDI IN terminal that allows MIDI selection of effect programs and a switchable MIDI THRU/OUT terminal. When switched to OUT, edited programs stored in the internal RAM memory can be dumped to a MIDI data recorder or other data storage devices. Programs thus stored can be reloaded when necessary via the MIDI IN terminal. As an extra touch of convenience, the SPX990's analog input and output terminals can be switched to match -20dBm or +4dBm line levels, providing compatibility with a broader range of sound equipment. In order to fully take advantage of all the capability offered by the SPX990 Professional Multi-effect Processor, we urge you to read this operation manual thoroughly while trying out the many features and effects provided by the SPX990.

CONTENTS

PRECAUTIONS 3

CONTROLS AND CONNECTIONS 4

THE FRONT PANEL	4
THE REAR PANEL	5

THE SPX990 SYSTEM 6

EFFECT CONFIGURATION	6
MEMORY CONFIGURATION	7
MEMORY CARD	7
MEMORY & EDIT MODES	8
SELECTING AN INPUT MODE	9
(Edit Mode: Page 5)	

GENERAL OPERATION 10

MEMORY RECALL	10
PRESET PROGRAM LIST	12
EDITING EFFECT PARAMETERS	14
(Edit Mode: Page 1)	
EDITING PROGRAM NAMES	15
(Edit Mode: Page 2)	
STORING A PROGRAM	16
USER'S MEMORY PROTECT FEATURE	17
(Edit Mode: Page 5)	
MEMORY CARD FUNCTIONS	18
(Edit Mode: Page 4)	
SELECTING A FOOT SWITCH FUNCTION	19
(BYPASS, INC/DEC TERMINAL)	
(Edit Mode: Page 5)	

THE PROGRAMS & PARAMETERS 20

STRUCTURE OF EFFECT PROGRAMS	20
PRE & POST EFFECT PARAMETERS	21
3-band Parametric Equalizer (P. EQ)	21
Compressor (Comp.)	22
Aural Exciter (AuralX)	22
Compressor, Distortion & EQ (Dist.)	23
PROGRAM MAIN EFFECT PARAMETERS	24
■ REVERB EFFECTS	25
Reverb (Reverb)	25
Filtered Reverb (FiltRev)	26
Stereo Reverb (St.Rev)	26
Echo Room (EchRoom)	27
● GATE	28
■ ER (EARLY REFLECTION) EFFECTS	29
Thin Early Reflection (ThinER)	29
Fat Early Reflection (FatER)	29
Gate Reverb (GateRev)	29
Reverse Gate (Reverse)	29
■ DELAY, ECHO EFFECTS	30
Delay L, C, R (Dly-LCR)	30
Echo (Echo)	31
Multi Tap Delay (Mlt. Tap)	32
Stereo Echo (St. Echo)	33

Tempo Mono Echo (TmpEch1)	35
Tempo Stereo Echo (TmpEch2)	36
Tempo Quad Echo (TmpEch4)	36
■ MODULATION EFFECTS	37
Flange (Flanger)	37
Dual Flange (DualFig)	37
FM Chorus (FM.Cho)	38
AM Chorus (AM.Cho)	38
Phaser (Phaser)	38
Symphonic (Symphon)	38
■ PITCH CHANGE EFFECTS	39
Mono Pitch Change (MonoPit)	39
Dual Pitch Change (DualPit)	41
Triple Pitch Change (TripPit)	41
Stereo Pitch Change (StPitch)	42
■ PAN EFFECTS	42
Auto Pan (AutoPan)	42
Triggered Pan (TrigPan)	43
■ COMPLEX EFFECTS	44
Chorus & Reverb (Cho&Rev)	44
Symphonic & Reverb (Sym&Rev)	44
Flanger & Reverb (Flg&Rev)	45
Reverb(L)/ Reverb(R) (Rev/Rev)	45
ER (L)/Reverb (R) (ER/Rev)	46
Echo (L)/ Reverb (R) (Ech/Rev)	47
Chorus(L)/ Reverb(R) (Cho/Rev)	48
Pan(L)/Pan(R) (Pan/Pan)	48
■ FREEZE EFFECT	49
Freeze (Freeze)	49

MIDI CONTROL 52

MIDI TERMINALS	52
MIDI OPERATIONS	52
MIDI PROGRAM CHANGE TABLE SETUP	55
(Edit Mode: Page 3)	
MIDI PARAMETER CONTROL	56
(Edit Mode: Pages 2 and 3)	
MIDI BULK OUT	58
(Edit Mode: Page 3)	

APPENDIX

SPECIFICATIONS	Add-1
OPTION	Add-1
BLOCK DIAGRAM	Add-4
DIMENSIONS	Add-4
MIDI DATA FORMAT	Add-5
MIDI Implementation Chart	Add-10
USER PROGRAMMING TABLE	Add-11
MIDI PROGRAM CHANGE LIST	Add-13

* Aural Exciter® is a registered trademark and is manufactured under license from Aphex Systems, Ltd.

PRECAUTIONS

1. AVOID EXCESSIVE HEAT, HUMIDITY, DUST AND VIBRATION

Keep the unit away from locations where it is likely to be exposed to high temperatures - such as in direct sunlight, near stoves, etc. Also avoid locations which are subject to excessive dust accumulation or vibration which could cause mechanical damage.

2. AVOID PHYSICAL SHOCK

Strong physical shocks to the unit can cause damage. Handle with care.

3. DO NOT OPEN THE CASE OR ATTEMPT REPAIRS OR MODIFICATIONS YOURSELF

This unit contains no user-serviceable parts. Refer all maintenance to qualified Yamaha service personnel. Opening the case and/or tampering with the internal circuitry will void the warranty.

4. MAKE SURE POWER IS OFF BEFORE MAKING OR REMOVING CONNECTIONS

Always turn the power OFF prior to connecting or disconnecting cables. This is important to prevent damage to the unit itself as well as other connected equipment.

5. HANDLE CABLES CAREFULLY

Always plug and unplug cables - including the AC cord - by gripping the connector, not the cord.

6. CLEAN WITH A SOFT DRY CLOTH

Never use solvents such as benzine or thinner to clean or aerosol spray to spray the unit. Wipe clean with a soft, dry cloth.

7. ALWAYS USE THE CORRECT POWER SUPPLY

Make sure that the power supply voltage specified on the rear panel matches your local AC main supply.

8. THUNDERSTORMS

Disconnect the unit quickly when there is any danger of lightning striking in your area.

9. ELECTRICAL INTERFERENCE

Since the unit contains digital circuitry, it may cause interference and noise if placed too close to TV sets, radios or similar equipment. If such a problem does occur, move the unit further away from the affected equipment.

10. MEMORY BACKUP

The SPX990 contains a special long-life battery that retains the contents of its internal RAM memory even when the power is turned OFF. The backup battery should last approximately 5 years. When the battery voltage drops to a level that is too low to maintain the memory contents, the message shown below will appear on the unit display when the power is turned ON.

It is recommended that as a back-up routine you save the data on memory card or store them in an external device using MIDI bulk dump (Program Change Table and System Data can not be copied to memory cards).

```
***** WARNING *****  
BATTERY ERROR
```

If this message appears, have the backup memory replaced by qualified Yamaha service personnel. Do not attempt to do it yourself.

NOTE: The preset programs will not be erased even if the battery voltage drops.

11. STORAGE

After reading this operation manual, please keep it and the warranty in a safe place for future reference.

12. ERROR MESSAGES

When the SPX990 power is initially turned ON, a self-diagnostic program runs automatically to check a number of important operational parameters. If a problem is detected, an error message (number E1 through E4) will appear on the MEMORY No. display. If an error message appears, please take the SPX990 to your nearest Yamaha dealer for servicing, and be sure to tell the service personnel which number was displayed.

System Initialization

To initialize the system press the PAGE Select ∇ key, STORE key and BYPASS key simultaneously with the power turned ON. Please note that the user memory contents will be erased and returned to the original settings.

CONTROLS AND CONNECTIONS

THE FRONT PANEL

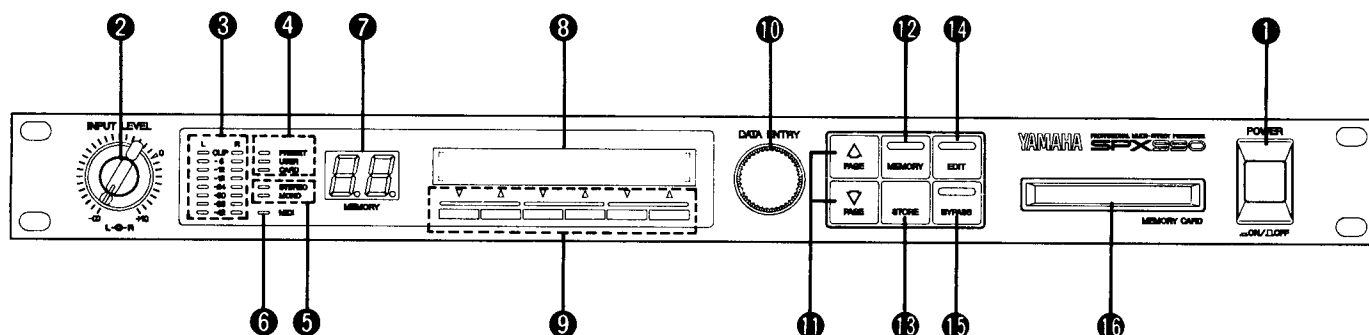

1 POWER Switch

Press to turn the power ON and OFF.

When the power is turned ON, the last program and parameter selected will be automatically recalled.

2 INPUT LEVEL Controls

These concentric controls vary the input level of the analog input. The inner control adjusts the Lch level and the outer control the Rch level.

3 Input Level Meter

The stereo input level meter consists of eight Lch and Rch segments per channel, corresponding to -42dB, -36dB, -30dB, -24db, -18dB, -12dB, -6dB and CLIP input.

4 Memory Indicators

Show the selected memory type : PRESET, USER or CARD.

5 Input Select Indicator

Show the input mode : STEREO or MONO (refer to page 9).

6 MIDI Indicator

The indicator will light up whenever a MIDI signal is received through the MIDI IN terminal.

7 MEMORY No. Display

Displays the memory No. of the program presently selected. The display flashes during memory No. selection and lights continuously upon execution of recall and store operations.

8 LCD Display

The LCD display indicates the titles of selected effects, parameter values, messages, etc.

9 Function Keys (▽ / ▲)

These keys are used for direct recall (see page 11) or normal recall as well as for store operations, and editing of parameters and values of functions show on the LCD display at the corresponding positions.

10 DATA ENTRY Dial

The dial allows changing the program memory No. or parameter values.

11 PAGE Select Keys (△ / ▽)

The △ and ▽ keys allow selection of menu numbers. Press the key corresponding to the direction in which you want to increment or decrement.

12 MEMORY Key and Indicator

This key is used to activate the memory mode. The indicator will light up when the key is pressed. The key is also used for selecting the memory type (PRESET, USER or CARD).

13 STORE Key

This key is used to store edited effect programs in one of the user memory location or the memory card. (For program storage, refer to page 16.)

14 EDIT Key and Indicator

Press this key to enter the edit mode. When the edit mode is activated, the indicator will light up.

15 BYPASS Key and Indicator

When this key is pressed, effects will be bypassed and the input signal is fed directly to the output. The indicator lights, while effects are bypassed.

16 MEMORY CARD Slot

An optional memory card (Yamaha MCD32 or MCD64) can be inserted to expand the storage capacity.

THE REAR PANEL

* Aural Exciter® is a registered trademark of Aphex Systems, Ltd.

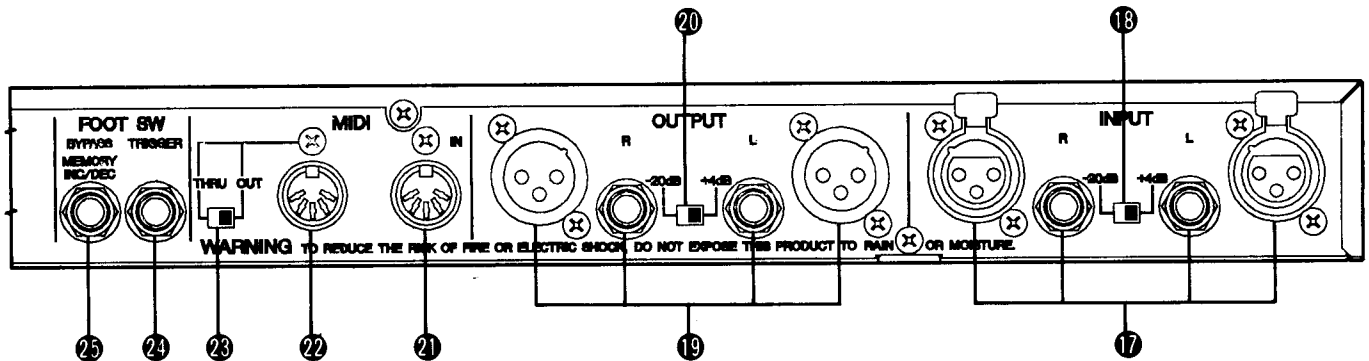

17 INPUT Connectors (L & R)

These are analog stereo input terminals. Both XLR-3-31 type connectors and TRS phone jacks are balanced inputs. Refer to "SELECTING AN INPUT MODE" on page 9 for connection to monaural sources.

18 Input Level Switch (+4dB/-20dB)

This switch allows switching between -20dB and +4dB nominal input level.

19 OUTPUT Connectors (L & R)

These are analog stereo output terminals. Both XLR-3-32 type connectors and TRS phone jacks are balanced outputs.

20 Output Level Switch (+4dB/-20dB)

This switch allows switching between -20dB and +4dB nominal output level.

21 MIDI IN Terminal

This terminal is used to receive MIDI signals from external MIDI devices.

22 MIDI OUT/THRU Terminals

23 OUT/THRU Switch

Used to select either MIDI THRU or MIDI OUT operation for the MIDI OUT/THRU connector as follows:

MIDI OUT

When the OUT/THRU switch is set to OUT, the internal data can be dumped to an external MIDI data recorder for storage.

MIDI THRU

When the OUT/THRU switch is set to THRU, the terminal simply re-transmits data received through the MIDI IN terminal, allowing daisy-chaining of several MIDI devices.

24 TRIGGER Footswitch Jack

An optional foot switch (Yamaha FC4 or FC5) connected to this terminal can be used to "tap" input parameter settings or to trigger the effect gate in the program selected.

25 BYPASS or MEMORY INC/DEC Footswitch Jack

This terminal can be used to switch settings in the edit mode using one of the two following functions (refer to page 19):

Bypass Function

When an optional footswitch (FC4 or FC5) is connected to the jack, it has the same function as the BYPASS Key 15 on the front panel.

Memory INC/DEC Function

When an optional footswitch (FC4 or FC5) is connected to the jack, it can be used to change programs.

THE SPX990 SYSTEM

EFFECT CONFIGURATION

The effect programs of the SPX990 consist of three separate effects – pre-effect, main effect and post-effect.

The unit offers 36 main effects, 4 pre-effects and 3 post-effects to choose from. The pre- and post-effects provide equalizing and dynamic control of the main effects.

In addition, each of these effects is controlled by a number of parameters for almost unlimited possibilities in the creation of effect programs.

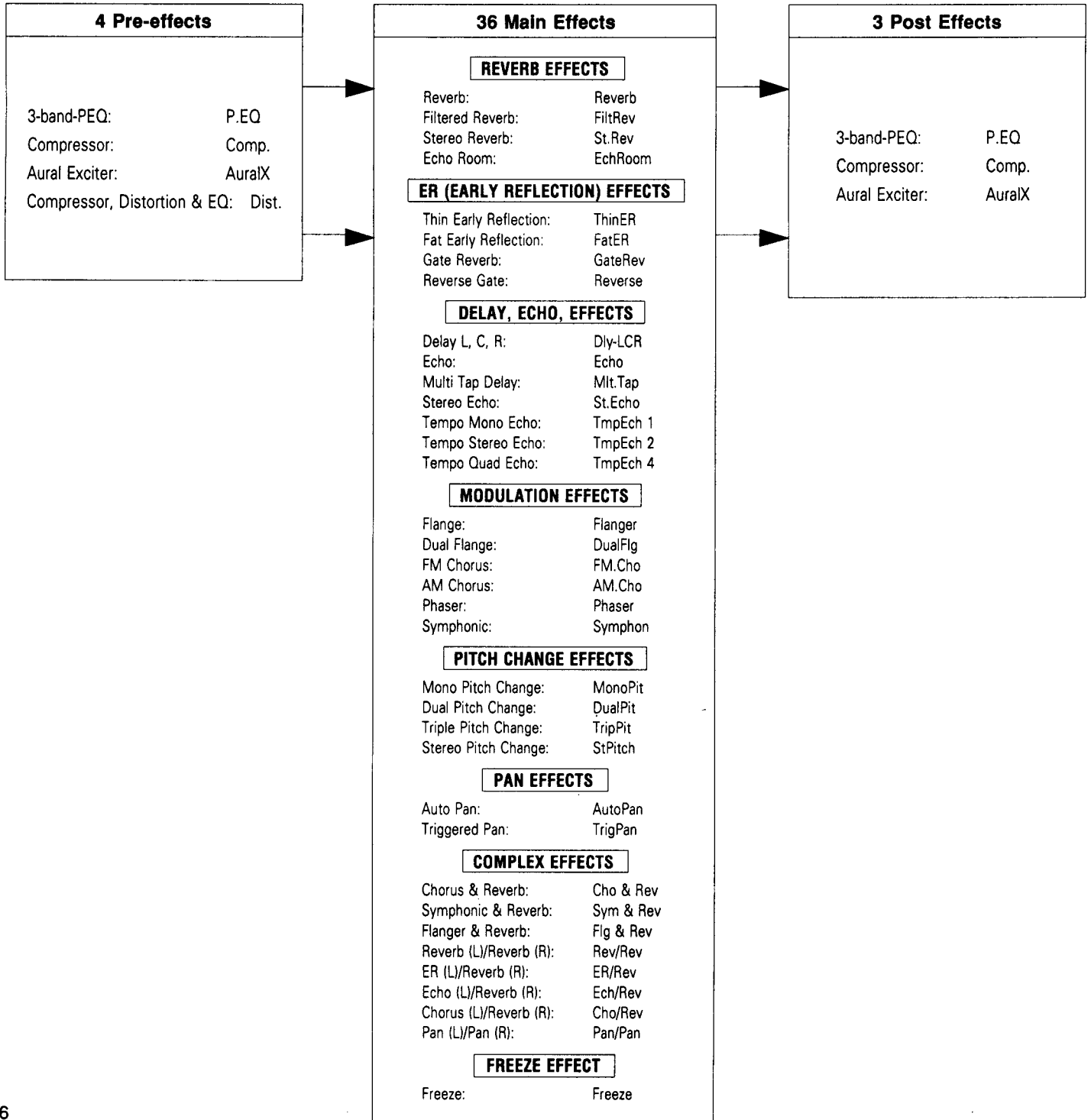

MEMORY CONFIGURATION

The SPX990 offers three types of memory which can hold a total of 280 programs for instant recall.

Preset Memory: No. 1-80 = 80 programs

The preset memory contains 80 effect programs (see page 12, "Preset Program List") that you can select and use without modification. The preset programs themselves cannot be erased or changed in any way, but they can be edited and stored in the USER or CARD memory to create original variations.

User Memory : No. 1-99, 00 =100 programs

The user memory provides 100 locations in which your own effect programs can be stored. You can edit a preset effect program to create an original variation. At the time of purchase, the user memory contains the same effect programs as the preset memory.

Card Memory: No. 1-99,00=100 programs

An optional memory card can be used to increase the memory capacity or create a program library. The memory card can be used to edit and store programs just like in the user memory and all programs in the user memory can also be stored on memory card for backup.

MEMORY CARD

Optional Yamaha memory cards (MCD32 or MCD64) can hold up to 100 effects each for virtually unlimited memory storage of your programs. These cards can be used to store user memory programs or to load stored programs into the user memory.

Memory Card Cautions

- When you use a memory card for the first time, be sure to format and initialize it first. (See page 18)
- Do not pull out the card while recalling (see page 10), storing (see page 16), saving (see page 18) or loading (see page 18) a program. Also, do not pull out the card when the memory indicator "CARD" is lit.
- Programs cannot be stored on a memory card when its write protect switch is set to "ON". Also, programs stored on memory card cannot be loaded, if the user memory protect function is set to "□H". (See page 17)
- The following memory card-related messages may be displayed during operation:
 - ① When there is no memory card present, "No Memory Card" will appear.
 - ② "Write Protect" is displayed when a card is write protected.
 - ③ When cards which cannot be used in the SPX990 are inserted or when cards are not initialized, "Wrong ID Card" will appear.

MEMORY & EDIT MODES

The SPX990 has two basic modes of operation:

Memory Mode

The memory mode allows calling and using effect programs. (see page 10). This mode is selected automatically when the power is turned ON.

Edit Mode

This mode is used for editing effect parameters. Press the EDIT key to enter this mode. There are 5 menu pages as shown below. For selection of pages, use the PAGE Select keys (Δ / ∇).

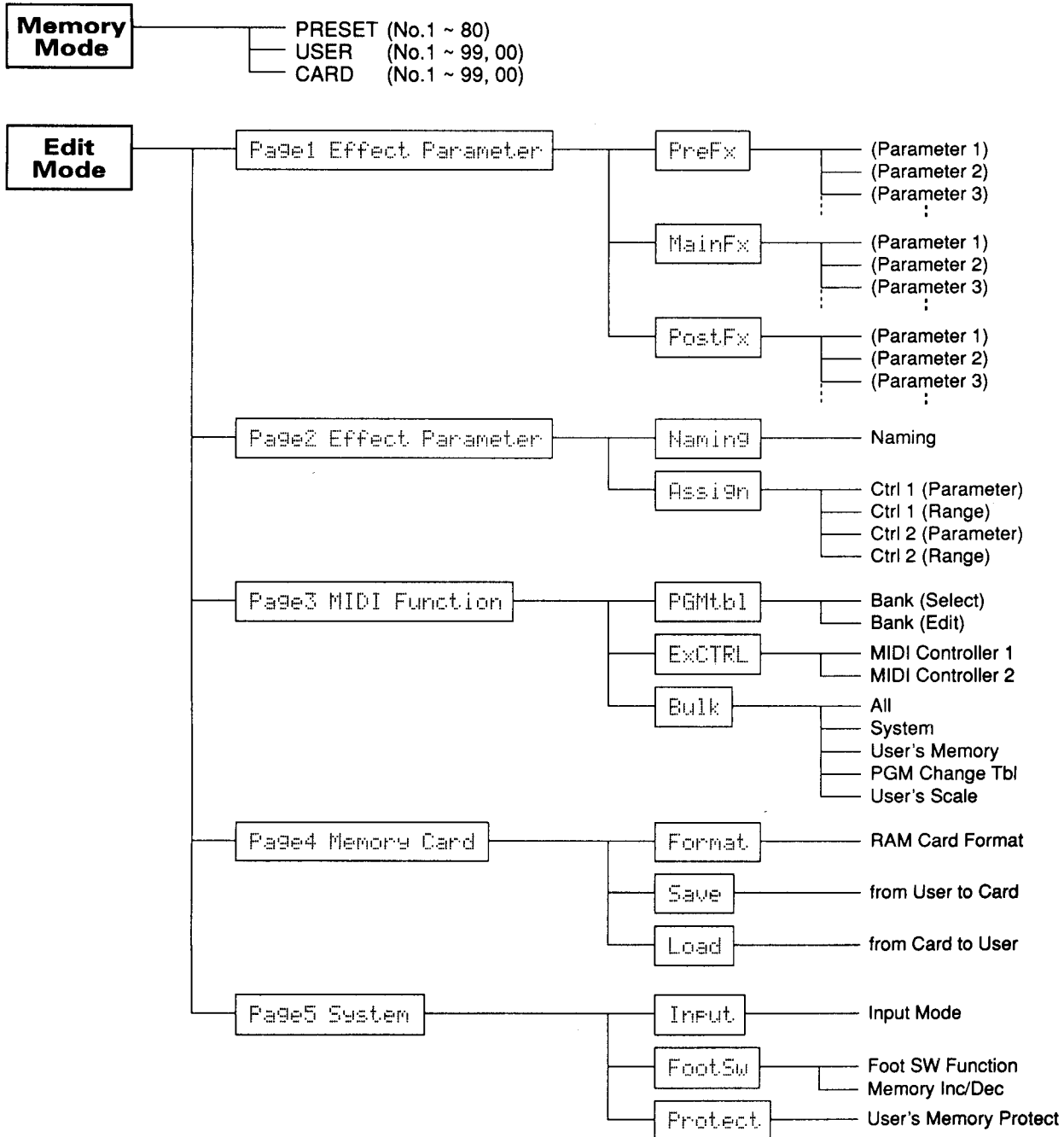

NOTE: To store an effect program, simply press the STORE key. The unit will automatically return to the memory mode. (See page 16)

NOTE: To return to the memory mode from the edit mode, press the MEMORY key.

SELECTING AN INPUT MODE (Edit Mode: Page 5)

The preset programs are complete and can be used immediately. Prior to actual use, however, there is one important setting to consider: the input mode.

Although the SPX990 is equipped with L and R stereo inputs, it can be set to mono input (L or R) to allow connection to monaural sources. In this case the monaural signal input through the L or R terminal is processed by the L and R circuits internally as shown below.

Stereo

This is the normal input mode in which left- and right-channel signals are input and processed separately by the SPX990 processing circuitry.

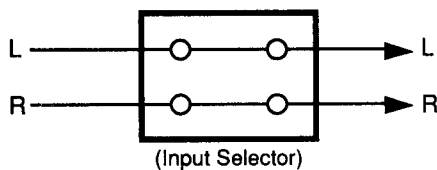

L Mono

In the L Mono mode, the signal of a monaural source connected to the INPUT L jack is fed to both the left- and right-channel processing circuitry for stereo processing. The INPUT R jack is disconnected.

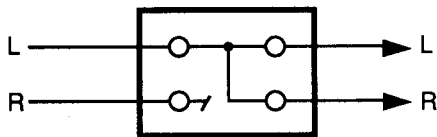

R Mono

In the R Mono mode the signal of a monaural source connected to the INPUT R jack is fed to both the left- and right-channel processing circuitry for stereo processing. The INPUT L jack is disconnected.

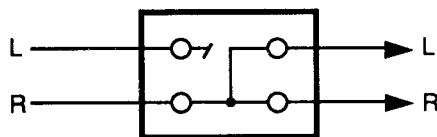

How to select an input mode

- Press the EDIT key to enter the edit mode. Then use the PAGE Select keys (Δ / ∇) to select Page5 on the LCD display.

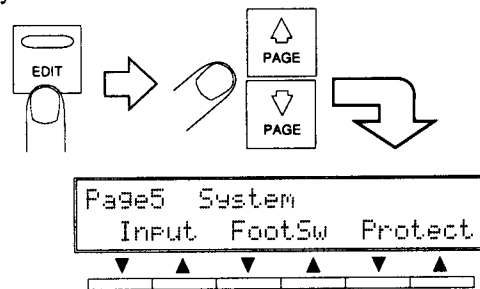

- Press either function key (∇ or Δ) under "Input" on the LCD display to change to the "Input Select" display.

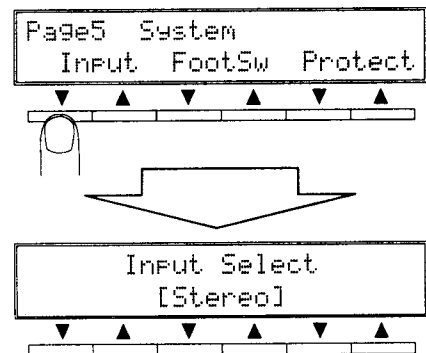

- Press either function key (∇ or Δ) under "Input Select" on the LCD display to select the input mode (Stereo, L Mono or R Mono).

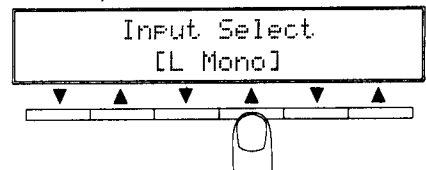

NOTE: If "L Mono" or "R Mono" is selected with a stereo source connected, the signal of the other channel will not be input. For this reason, please make sure that the selected input mode matches the source.

NOTE: The input mode selection applies to all programs. The setting remains in memory, even if the power is turned off.

- Press the EDIT key to return to Page1 of the edit mode or the MEMORY key to return to the memory mode.

GENERAL OPERATION

MEMORY RECALL

There are 3 methods to recall a program:

1. Recall using panel keys standard method.
2. Direct recall one-touch recall by simply pressing one function key (▼ or ▲).
3. MIDI program change recall from an external MIDI device. (see page 52)

1. Recalling a program using the panel keys

- ① Press the MEMORY key to enter the memory mode.
The memory indicator will light up.

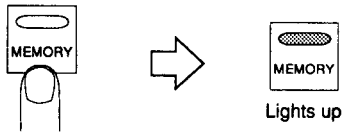

- ② Press the MEMORY key to select the desired memory type: "PRESET", "USER" or "CARD".

NOTE: To recall a program from a memory card, the card must be inserted first.

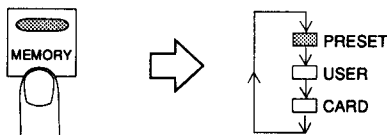

- ③ Turn the DATA ENTRY dial to select the desired program memory No. The memory No. flashes on the MEMORY display, while the program name is shown on the LCD display. The sound, however, will still be that of the previously selected program.

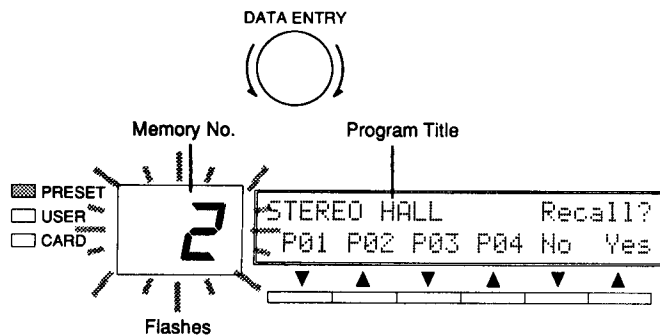

- ④ Press the ▲ function key under "Yes" (the memory No. indication will light up) to recall the program. After recalling the program, the name of the main effect program will appear on the right side of the LCD.

Press the ▼ function key under "No" if you want to cancel the recall operation and return to the previously selected program.

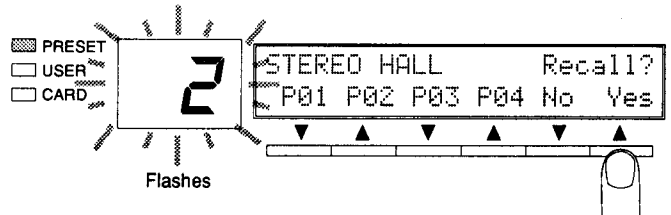

2. Direct Recall

Using the direct recall function, you can assign a specific program number from any memory type to one function key (▼ / ▲) for instant recall.

In the example shown below, the preset program No. 1 (P01) can be recalled by pressing the corresponding ▲ function key. Pressing the key at the very left will recall user program No. 5 (U05).

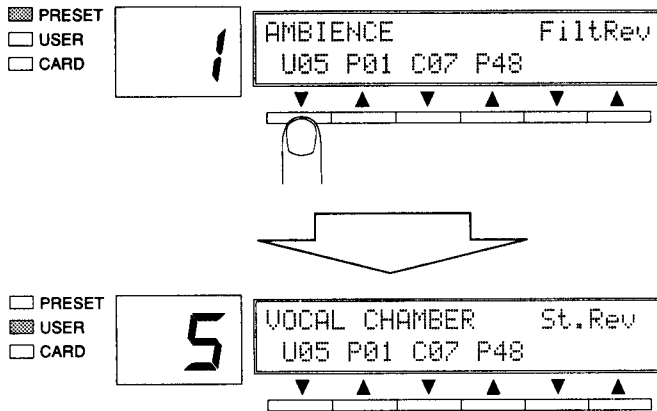

In this way you can conveniently assign frequently used programs to specific function keys and then have the direct recall function perform steps ② to ④ of “Recalling a program using the panel keys” in an one-touch operation.

The four function keys from the left may be used for direct recall and can be assigned to any program of any of the three memory types. Assignments will remain in memory even if the power is turned off.

NOTE: Direct recall can be performed in the memory mode only. If in any other mode, press the MEMORY key first (the MEMORY indicator will light up).

NOTE: To directly recall a program from a memory card, the card must be inserted first. If there is no card in the slot, “No Memory Card” will appear on the display and the recall command is ignored.

How to assign a program for direct recall

- ① Perform steps ①-③ in “1. Recalling a program using the panel keys” to recall the desired program.
- ② When the memory No. flashes on the display, press the function key to which you want to assign the program.

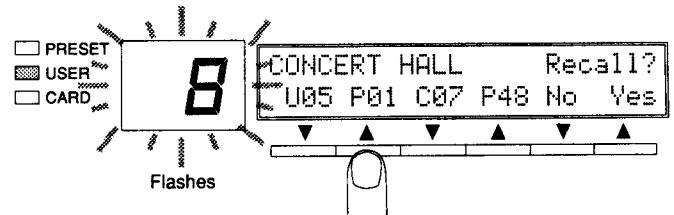

- ③ The program is now assigned. Its memory number is displayed above the function key and the program will be recalled simultaneously.

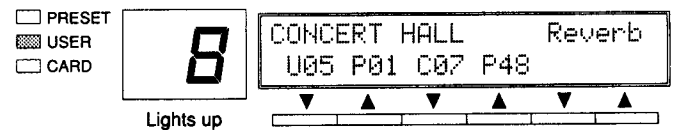

The memory type is identified by the letter in front of the two-digit number:

P = PRESET, U = USER, C = CARD

- ④ Other programs can be assigned to other function keys in the same way.

PRESET PROGRAM LIST

MEMORY NO.	PROGRAM NAME	EFFECT			SUITABLE FOR
		PreFx	MainFx	PostFx	
LONG REVERBS					
1	AMBIENCE	P.EQ	FiltRev	off	All
2	STEREO HALL	off	St.Rev	off	E.Piano, Vocal
3	DRUM CHAMBER	P.EQ	ER/Rev	off	ER for Tom / REV for Snare
4	PLATE HALL	off	Rev/Rev	off	PLATE for Vocal, HALL for Inst.
5	VOCAL CHAMBER	off	St.Rev	Comp.	Vocal
6	BRIGHT HALL	off	FiltRev	off	All
7	BREATHY REVERB	P.EQ	FiltRev	AuralX	Female Vocal, Keyboard
8	CONCERT HALL	off	Reverb	off	Keyboard (Pad)
9	REVERB FLANGE	off	Flg&Rev	P.EQ	All
MEDIUM REVERBS					
10	VOCAL PLATE	P.EQ	Reverb	P.EQ	Vocal, All
11	ECHO ROOM	off	EchRoom	off	All
12	PRESENCE REVERB	off	FiltRev	P.EQ	Brass, Woodwind
13	SNARE PLATE	off	FiltRev	off	Snare, Drums, Percussion
14	ARENA	off	Reverb	off	Drums
15	THIN PLATE	off	St.Rev	P.EQ	Vocal
16	OLD PLATE	P.EQ	FiltRev	off	Snare
ROOMS					
17	FAT REFLECTIONS	P.EQ	FatER	Comp.	Drums, Percussion
18	WOOD ROOM	off	EchRoom	AuralX	Drums, Percussion
19	BIG SNARE	off	GateRev	off	Snare
20	BRIGHT SNARE	P.EQ	FiltRev	Comp.	Snare
21	SQUASH ROOM	P.EQ	EchRoom	Comp.	Rock Drums, Guitar
22	BAMBOO ROOM	off	EchRoom	off	Percussion
23	REFLECTIONS	off	ThinER	P.EQ	All
24	STONE ROOM	off	FiltRev	P.EQ	All
25	CONCRETE ROOM	off	GateRev	off	Metal Guitar
GATED REVERBS					
26	BLATTY PLATE	P.EQ	FiltRev	P.EQ	Drums
27	FULL METAL GATE	P.EQ	GateRev	P.EQ	Drums
28	HARD GATE	P.EQ	GateRev	Comp.	Snare
29	REVERSE GATE	P.EQ	Reverse	Comp.	Guitar Solo, Vocal
30	REVERSE PURPLE	off	Reverse	P.EQ	Drums
DRUM MACHINE REVERBS					
31	DRUM MACH. AMB.S	off	St.Rev	P.EQ	Hi-hat, Snare
32	DRUM MACH. AMB.L	off	FiltRev	off	Percussion, Snare
33	ELECT.SNR PLATE	P.EQ	Reverse	Comp.	Snare
DELAYS					
34	SYNC DELAY	off	TmpEch4	off	Rock Vocal
35	VOICE DOUBLER	off	DualPit	off	Vocal
36	DELAY L, C, R	off	Dly-LCR	off	All
37	120 BPM PAN DDL	off	TmpEch2	off	Vocal, Hi-hat < ♩ = 120 >
38	120 BPM MONO DLY	off	TmpEch1	off	Vocal < ♩ = 120 >
39	MULTI TAP DELAY	off	Mlt.Tap	P.EQ	Vocal
40	KARAOKE ECHO	off	St.Echo	P.EQ	Karaoke Vocal

MEMORY NO.	PROGRAM NAME	EFFECT			SUITABLE FOR
		PreFx	MainFx	PostFx	
PITCH EFFECTS					
41	GOOD OL P.CHANGE	off	DualPit	off	All
42	VOCAL SHIFT	Comp.	DualPit	off	Vocal, Backing
43	AIRY PITCH	AuralX	DualPit	P.EQ	Vocal
44	ANALOGUE SLAP	AuralX	DualPit	P.EQ	Vocal
45	FAT BASS	P.EQ	TripPit	off	Synth Bass
46	"LOW" SNARE	P.EQ	DualPit	P.EQ	Snare, Drums
47	HALO COMB	AuralX	DualPit	Comp.	Drums
48	GRUMPY FLUTTER	AuralX	DualPit	P.EQ	<Descending Pitch Effect>
49	ROGER ON THE 12	off	MonoPit	off	Guitar
50	TWISTER	off	DualPit	AuralX	Percussion
51	BOTTOM WHACKER	P.EQ	DualPit	off	Drums
52	INTELLICHORD MON	off	MonoPit	off	C maj Scale, Vocal, Guitar <mono Input>
53	INTELLICHORD DUA	off	DualPit	off	C maj Scale, Vocal, Guitar <mono Input>
54	INTELLICHORD TRI	off	TripPit	off	C maj Scale, Vocal, Guitar <mono Input>
55	PITCH SLAP	AuralX	DualPit	off	Vocal
56	STEREO PITCH	off	StPitch	off	Vocal <key shift>
MODULATION EFFECTS					
57	SYMPHONIC	off	Symphon	off	Guitar, Keyboard
58	GTR SYM ECHO	AuralX	Sym&Rev	P.EQ	Guitar, Keyboard
59	CHORUS & REVERB	off	Cho&Rev	off	Guitar, Keyboard
60	BASS CHORUS	off	DualPit	off	Bass
61	STEREO PHASING	off	Phaser	off	Guitar
62	CLASSY GLASSY	AuralX	FM.Cho	P.EQ	Keyboard (Pad)
63	SILKY SWEEP	AuralX	Phaser	P.EQ	All
64	DETUNE CHORUS	off	DualFlg	off	All
65	UP DOWN FLANGE	P.EQ	Flanger	P.EQ	Guitar
66	UNDERWATER MOON	P.EQ	Cho/Rev	AuralX	Keyboard (Pad), Guitar
67	TREMOLO	off	AutoPan	off	Guitar, Keyboard
68	ROTARY SP.	Dist.	AM.Cho	off	Keyboard (Organ)
PROCESSING EFFECTS					
69	FREEZE	off	Freeze	off	Sampling
70	DIST. PERCUSSION	Dist.	ThinER	Comp.	Percussion
71	DISTORTION 1	Dist.	ThinER	Comp.	Bass, Vocal
72	PAN	off	AutoPan	off	All
73	TRIGGERED PAN	off	TrigPan	off	All
74	PAN / PAN	off	Pan/Pan	off	Keyboard
SOUND EFFECTS					
75	ON THE PHONE	P.EQ	Echo	Comp.	Telephone Voice
76	IRON MAN	P.EQ	Dly-LCR	Comp.	Robot Voice
77	RADIO BLAG	P.EQ	Flanger	off	Radio Sound
78	TUNNEL	off	EchRoom	P.EQ	Tunnel Reverb
79	FOREVERVERB	off	St.Rev	off	Very Long Reverb
80	SILVERHEART	P.EQ	Ech/Rev	AuralX	Echo with fast Repeat

EDITING EFFECT PARAMETERS (Edit Mode: Page 1)

Each program has different changeable parameters. Original programs can be created by editing these parameters. The number of parameters and their types depend on each effect, but the procedure for editing is the same for all programs.

Editing procedure

- ① Select and recall the program to be edited (refer to “Memory Recall” on page 10).
- ② Press the EDIT key to enter the edit mode. The edit indicator will light up.

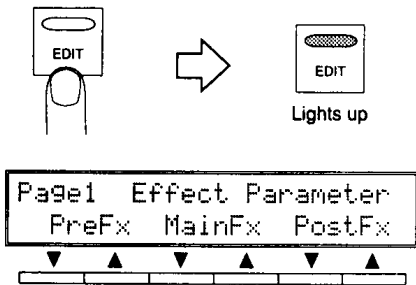

- ③ Press the ▼ or ▲ function key under the effect shown on the LCD display to change to page 1 of the parameter setting menu which shows the settings of the PreFx, MainFx or PostFx effect parameters (refer to “Selecting an Effect” on page 20).

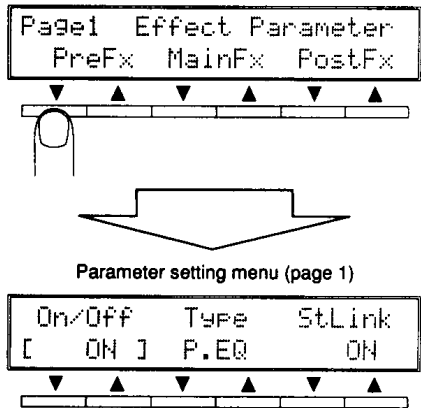

- ④ The top line in the LCD display shows the parameter names and the bottom line shows the corresponding settings.

Press the (▼ or ▲) function key under the parameter to be edited to select it. The bracket will move to the parameter whose function key was pressed.

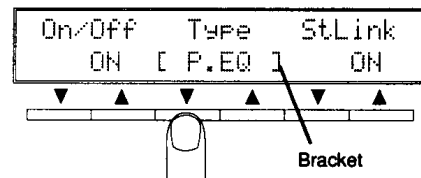

- ⑤ The parameter setting can be changed using the ▼ and ▲ function keys or the DATA ENTRY dial.

NOTE: The speed at which the parameter setting changes depends on how fast you turn the dial.

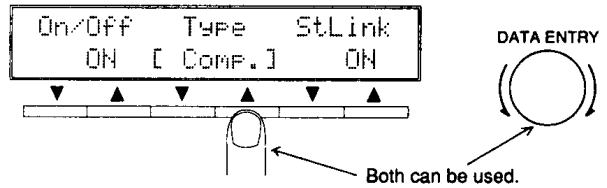

- ⑥ Use the PAGE Select keys (△ / ▽) to select the menu screen to be edited next. Edit the parameters as shown in steps ④ and ⑤. The number of parameters and its variation are different for each effect (refer to “THE PROGRAMS & PARAMETERS” on page 20).
- ⑦ Press the EDIT key to return to Page1 of the edit mode. Other effect parameters can also be edited if necessary.
- ⑧ The edited parameter settings will remain in memory when the power is turned off. However, if you recall the original program, the settings will be lost, unless you store them in the user memory first (see page 16).
- ⑨ Press the MEMORY key to return to the memory mode.

EDITING PROGRAM NAMES (Edit Mode: Page 2)

After editing a program you can change the original name (max. 16 letters) and store the new program with a more suitable name.

Naming procedure

- ① Select and recall the program to be edited (refer to “Memory Recall” on page 10).
- ② Press the EDIT key to enter the edit mode and use the PAGE Select keys (▲ / ▼) to select Page2 of the edit mode.

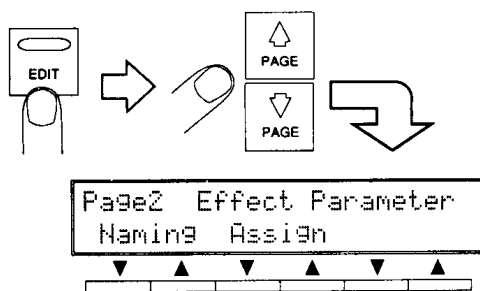

- ③ Press the (▼ or ▲) function key under “Naming” which is on the bottom line of the LCD display change to the naming menu screen.

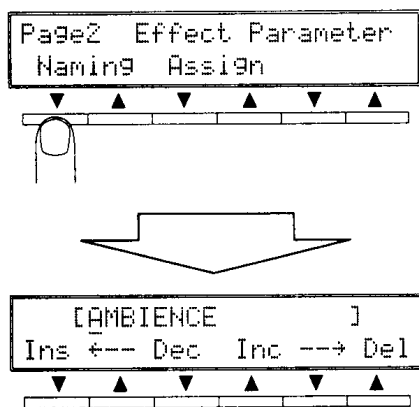

- ④ Use the ▲ and ▼ function keys under “←--” and “--→” on the display to move the cursor to the letter to be changed. Select the new letter using the ▲ and ▼ function keys under “Inc” and “Dec” or the DATA ENTRY dial.

The letters change in the sequence shown below. The ▼ function key under “Inc” allows inserting a letter at the current position, while the ▲ function key under “Del” can be used for deleting letters.

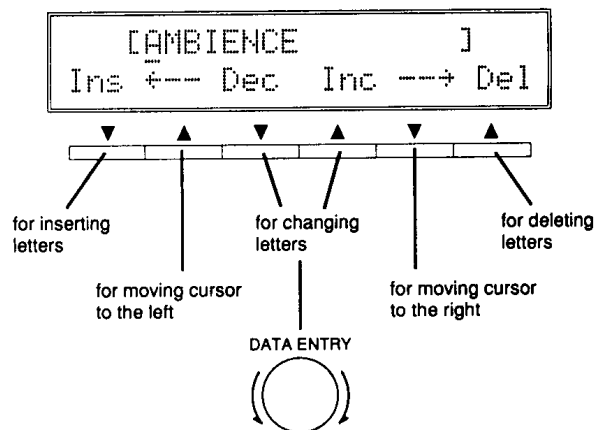

■ The available letters are selected in the following sequence.

	A	B	C	D	E	F	G	H	I	J	K	L	M	N	O	P	Q
R	S	T	U	V	W	X	Y	Z		a	ä	b	c	d	e	f	g
h	i	j	k	l	m	n	ö	ö	p	q	r	s	t	u	ü	v	w
x	y	z		[]	<	>	:	.	*	+	-	=	&	/	,	.
'	%	!	?	→	←	[]	'	'	-	ア	アイ	イウ	ウ			
エ	エ	オ	オ	カ	キ	ク	ケ	コ	サ	シ	ス	セ	ソ	タ	チ	ツ	テ
ト	ナ	ニ	ヌ	ネ	ノ	ハ	ヒ	フ	ヘ	ホ	マ	ミ	ム	メ	モ	ヤ	ャ
ユ	ユ	ヨ	ヨ	ラ	リ	ル	レ	ロ	ワ	ヲ	ン		#	0	1	2	3
4	5	6	7	8	9												

- ⑤ Store the effect program (see “STORING A PROGRAM” on page 16).

STORING A PROGRAM

After editing a program from one of the three memory types (PRESET, USER or CARD) you can store the newly created program in the user or card memory for later use.

The user or card memory may also be used to "copy" programs from the three memory types to subsequent user or card memory locations in the order they will be used during actual performance.

Storing procedure

- ① Set User's Memory Protect to OFF before storing a program (refer to "USER'S MEMORY PROTECT FEATURE" on page 17).

NOTE: Skip this step if User's Memory Protect is already set to "OFF".

NOTE: After storing a program, you can avoid accidental erasure of programs in the USER memory by setting User's Memory Protect back to "ON".

- ② If you want to store a program other than the one which is presently recalled, recall that program.

- ③ Press the STORE key to activate the "Store" mode.

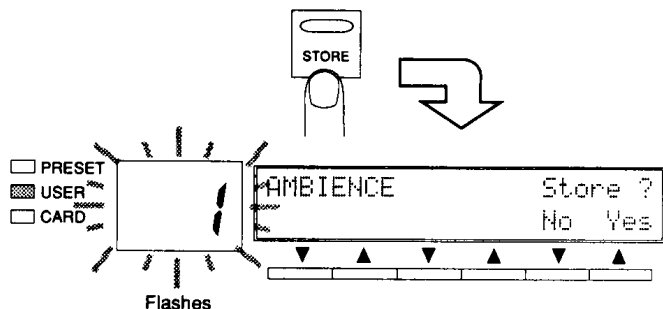

- ④ Press the MEMORY key to select USER or CARD.

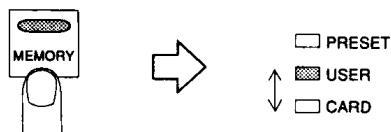

NOTE: When storing an edited program on a memory card, set its WRITE PROTECT switch to OFF first. Then, insert the card into the card slot before selecting the CARD memory.

NOTE: You cannot store edited programs in the PRESET memory.

- ⑤ Turn the DATA ENTRY dial to select the memory No. in which you want to store the program. The MEMORY No. indicator will flash and the name of the program stored previously will appear on the LCD.

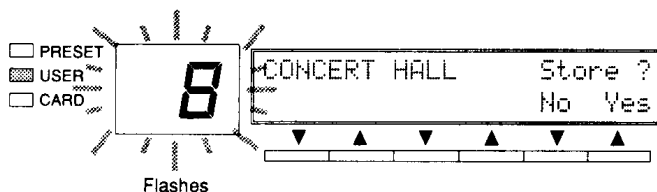

- ⑥ Press the ▲ function key under "Yes" or the STORE key once again to store the program recalled in the memory No. selected in step ⑤. The memory No. indicator will stop flashing and the store operation is executed.

If you want to cancel the store operation prior to execution, press the function ▼ key under "No".

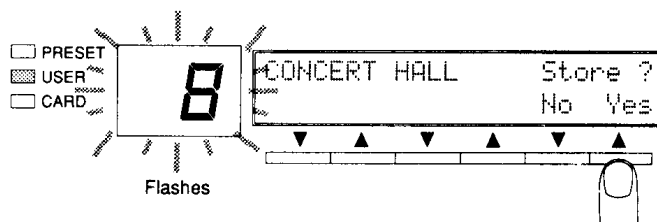

NOTE: When you store a program, the program previously stored in the selected memory No. is deleted.

NOTE: You can rename the new program (refer to "EDITING PROGRAM NAMES" on page 15).

NOTE: The BYPASS ON/OFF setting is stored in the same way as parameter data.

NOTE: You can copy (load) all data on a memory card to the user memory or copy (save) all data in the user memory onto a memory card (refer to "MEMORY CARD FUNCTIONS" on page 18).

USER'S MEMORY PROTECT FEATURE (Edit Mode: Page 5)

You cannot store any edited data in the user memory if User's Memory Protect is set to ON.
As long as the User's Memory Protect is set to ON, programs cannot be stored in the user memory to avoid accidental erasure of programs when the STORE command is executed by mistake.

Turning User's Memory Protect ON/OFF

- ① Press the EDIT key to enter the edit mode. Then use the PAGE Select keys (▲ / ▼) to display Page5 of the edit mode.

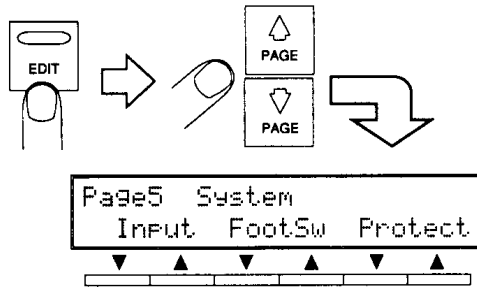

- ② Press the ▼ or ▲ function key below "Protect" to display the "User's Memory Protect" screen.

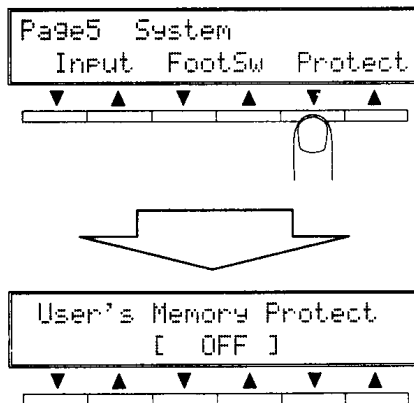

- ③ Select "ON" or "OFF" using the ▼ and ▲ function keys below the bracket [].
- ④ Press the EDIT key to return to Page5 of the edit mode or the MEMORY key to return to the memory mode.

MEMORY CARD FUNCTIONS (Edit Mode: Page 4)

The following functions are available for use with memory cards:

- Format Formats an MCD32 or MCD64 memory card.
- Save Copies all user memory data to the memory card.
- Load Copies all memory card data to the user memory.

Using Memory Cards

- ① Insert the MCD32 or MCD64 memory card into the memory card slot until it stops.
- ② Press the EDIT key to enter the edit mode. Then use the PAGE Select keys (▲ / ▼) keys to display Page4 of the edit mode.

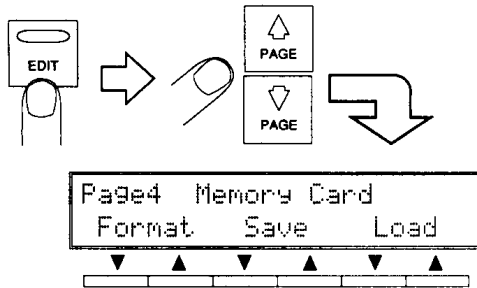

- ③ "Format", "Save" and "Load" are displayed on the bottom line of the LCD. Press the (▼ or ▲) function key below the function to be executed to display its confirmation screen.

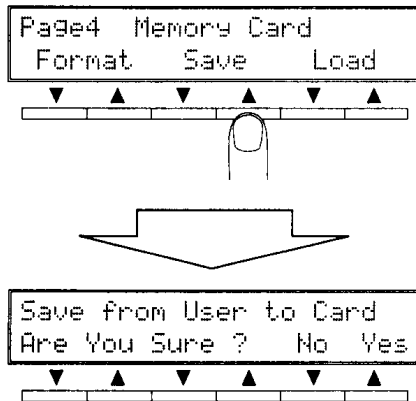

- ④ Press the ▲ function key under "Yes" to execute the function selected.

To cancel the operation prior to execution, press the ▼ function key under "No".

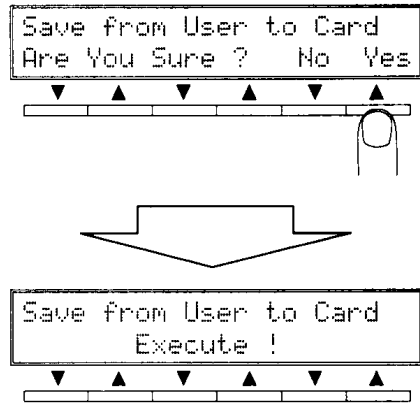

- ⑤ Press the EDIT key to return to the Page4 of the edit mode or the MEMORY key to return to the memory mode.

NOTE: When formatting a memory card, all data previously stored on the card will be erased and replaced by preset data automatically.

NOTE: To format a memory card or store data on it you must set its write protect switch to "OFF". Do not forget to set it back to "ON" later to prevent stored data from being erased accidentally.

SELECTING A FOOT SWITCH FUNCTION (BYPASS, INC/DEC TERMINAL) (Edit Mode: Page 5)

The BYPASS, INC/DEC terminal on the rear panel can be used to connect an optional Yamaha foot switch (FC4 or FC5). One of the following two foot switch functions can be selected:

- **BYPASS function**

With this function the foot switch performs the same operation as the BYPASS key on the front panel.

- **Memory INC/DEC function**

Allows recalling selected programs within a certain range – using the foot switch.

Each time the foot switch is pressed, the unit changes to the next or previous program in sequence.

NOTE: For live performances programs can be conveniently arranged in sequence in the user or card memory and then recalled using the foot switch.

Using the foot switch

- ① Press the EDIT key to enter the edit mode. Then use the PAGE Select keys (▲ / ▼) to display Page5 of the edit menu.

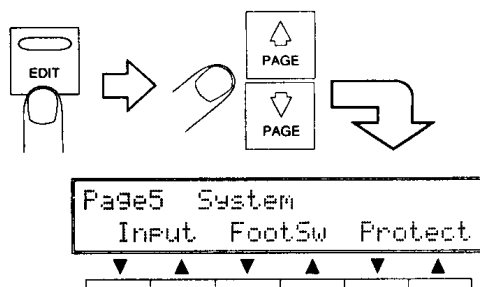

- ② Press the ▼ or ▲ function key under “FootSw” to select the “Foot Switch Function” menu screen.

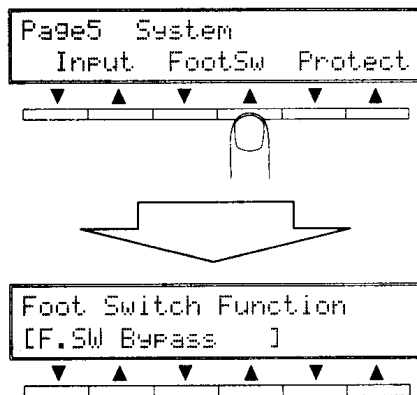

- ③ To select either “Memory Inc/Dec” or “Bypass” press the corresponding ▼ or ▲ function key.

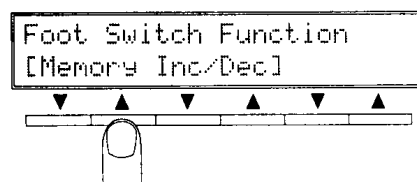

- ④ If you have selected the “Memory Inc/Dec” function, press the ▲ PAGE Select key to go to the next menu screen.

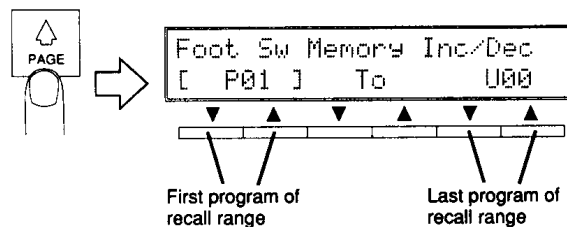

- ⑤ Use the two left function keys to specify the memory No. of the first program of the recall range for foot switch operation. The letter preceding the two-digit number identifies the memory type: P= PRESET, U= USER, C= CARD.
- ⑥ Set the last program of the recall range using the two right ▼ and ▲ function keys.
- ⑦ Press the EDIT key to return to Page5 of the edit mode or the MEMORY key to return to the memory mode.

The recall range setting is memorized automatically without having to press the STORE key.

- **Example for a recall range setting**

Each time the foot switch is pressed, the program will change in sequence.

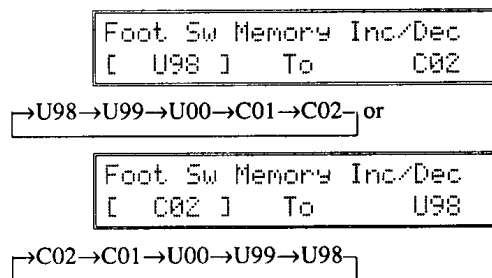

THE PROGRAMS & PARAMETERS

With the SPX-990 you can edit any of the preset programs (P01 to P80) to create your own original programs. For successful editing it is important that you familiarize yourself with the structure of effect programs in general and the function of each parameter.

Parameters marked "★" cannot be controlled by MIDI messages (see "MIDI PARAMETER CONTROL" on page 56).

STRUCTURE OF EFFECT PROGRAMS

As explained before, each program is made up of 3 individual effects: pre-effect, main effect and post-effect. There are 4 types of pre-effects, 36 types of main effects and 3 types of post effects.

Selecting an effect can be done on Page1 of the edit mode (refer to "EDITING EFFECT PARAMETERS" on page 14).

● PreFx, PostFx

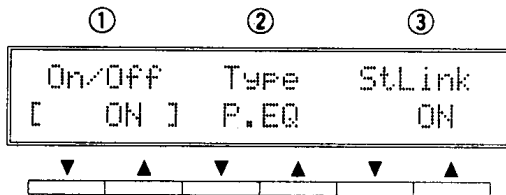

① On/Off (Effect On/Off: ON, OFF)

Can be used to turn the pre-/post-effect ON or OFF.

② Type (Effect Type: P.EQ, Comp., AuralX, Dist.) ★

Used to specify the desired effect.

NOTE: Dist. cannot be selected for the post effect.

NOTE: Refer to "PRE- & POST- EFFECT PARAMETERS" for explanation on the effects.

③ StLink (Stereo Link: ON, OFF)

When set to "ON", if a parameter of one channel is changed, the same change will be applied to the other channel automatically. Also, if the effect type "COMP." is selected, compression will be applied equally to Lch and Rch when the channels are linked.

NOTE: When the "Dist." effect type is selected, "StLink" will not be displayed.

● MainFx

NOTE: The main effect cannot be changed in the edit mode.

Therefore, as a base for creating an original program you must select a preset program that already contains the desired main effect.

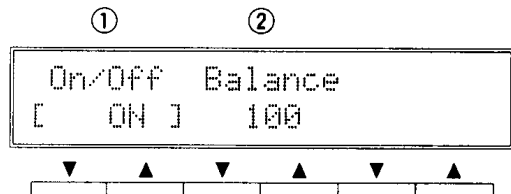

① On/Off (Main Effect On/Off: ON, OFF)

Can be used to turn the main effect ON or OFF.

② Balance (Mix Balance: 0% ~ 100%)

This parameter adjusts the mixing balance between the direct sound and the effect sound. At 0%, only the direct sound is output, while at 100% only the effect sound is output.

Some of the post-effects feature two effect types with individual mixing balance parameters.

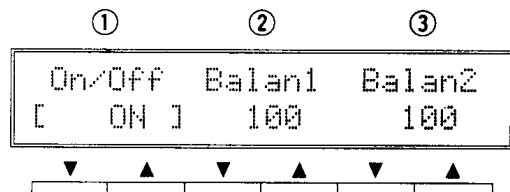

① On/Off (Main Effect On/Off: ON/OFF)

Can be used to turn the main effect ON or OFF.

② Balan 1 (Type 1 Mix Balance: 0% ~ 100%)

③ Balan 2 (Type 2 Mix Balance: 0% ~ 100%)

These parameters adjust the mixing balance between the direct sound and the Type 1 effect sound (② Balan 1) and the direct sound and the Type 2 effect sound (③ Balan 2).

NOTE: For detailed information on Type 1 and Type 2 effect sounds refer to the explanations on the respective programs.

PRE- & POST-EFFECT PARAMETERS

The following four types of pre- and post-effects are available:

- P. EQ Parametric Equalizer
- Comp. Compressor
- AuralX Aural Exciter
- Dist. Compressor, Distortion & Equalizer (only for pre-effect)

Name of effect	(LCD display)	in/out
3-band Parametric Equalizer (P. EQ)		2in/2out

This is a stereo IN/OUT parametric equalizer. The effect of the 3-band parametric equalizer can be set independently the left and right channels.

① **L.LoF (Lch Low Frequency: 40Hz ~ 1.0kHz)**

This parameter determines the center frequency for boost or cut applied to the Lch low frequency equalizer band.

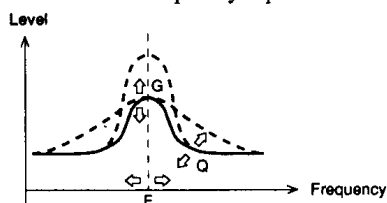

② **L.LoG (Lch Low Gain: -15dB ~ +15dB)**

Determines the amount of boost or cut applied to the Lch low frequency equalizer band.

③ **L.LoQ (Lch Low Q: 0.1 ~ 10.0)**

This parameter determines the peak sharpness (steepness) of the Lch low frequency equalizer.

④ **R.LoF (Rch Low Frequency: 40Hz ~ 1.0kHz)**

⑤ **R.LoG (Rch Low Gain: -15dB ~ +15dB)**

⑥ **R.LoQ (Rch Low Q: 0.1 ~ 10.0)**

These Rch parameters have the same functions as ①, ②, and ③.

⑦ **L.MiF (Lch Mid Frequency : 250Hz ~ 4.0kHz)**

Determines the center frequency for boost or cut applied to the Lch mid frequency equalizer band.

⑧ **L.MiG (Lch Mid Gain: -15dB ~ +15dB)**

Determines the amount of boost or cut applied to the Lch mid frequency equalizer band.

⑨ **L.MiQ (Lch Mid Q: 0.1 ~ 10.0)**

Determines the peak sharpness (steepness) of the Lch mid frequency equalizer.

⑩ **R.MiF (Rch Mid Frequency: 250Hz ~ 4.0kHz)**

⑪ **R.MiG (Rch Mid Gain: -15dB ~ +15dB)**

⑫ **R.MiQ (Rch Mid Q: 0.1 ~ 10.0)**

These Rch parameters have the same functions as ⑦, ⑧, and ⑨.

⑬ **L.HiF (Lch High Frequency: 1.0kHz ~ 16kHz)**

Determines the center frequency for boost or cut applied to the Lch high frequency equalizer band.

⑭ **L.HiG (Lch High Gain: -15dB ~ +15dB)**

This parameter determines the amount of boost or cut applied to the Lch high frequency equalizer band.

⑮ **L.HiQ (Lch High Q: 0.1 ~ 10.0)**

This parameter determines the peak sharpness (steepness) of the Lch high frequency equalizer.

⑯ **R.HiF (Rch High Frequency: 1.0kHz ~ 16kHz)**

⑰ **R.HiG (Rch High Gain: -15dB ~ +15dB)**

⑱ **R.HiQ (Rch High Q: 0.1 ~ 10.0)**

These Rch parameters have the same functions as ⑬, ⑭, and ⑮.

⑲ **L.HPF (Lch HPF Frequency: THRU, 20Hz ~ 1.0kHz)**

Determines the Lch high pass filter's cut-off frequency. Frequencies below the set frequency will be cut off at 12dB/oct.

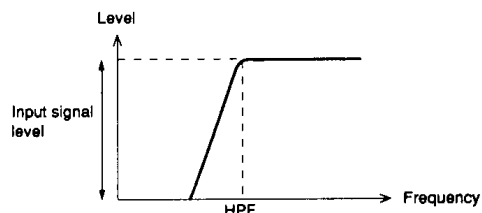

⑳ **L.LPF (Lch LPF Frequency: 1.0kHz ~ 16kHz, THRU)**

Determines the Lch low pass filter's cut off frequency. Frequencies above the set frequency will be cut-off at 12dB/oct.

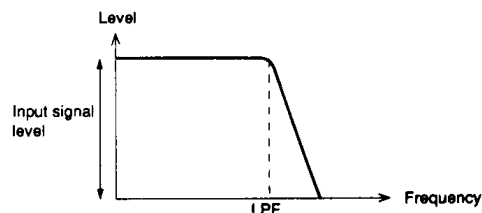

㉑ **L.Lvl (Lch Output Level: -∞, -30dB ~ +6dB)**

Determines the Lch level for the following main effect (pre-effect) or the output level (post-effect).

㉒ **R.HPF (Rch HPF Frequency: THRU, 20Hz ~ 1.0kHz)**

㉓ **R.LPF (Rch LPF Frequency: 1.0kHz ~ 16kHz, THRU)**

㉔ **R.Lvl (Rch Output Level: -∞, -30dB ~ +6dB)**

These Rch parameters have the same functions as ⑲, ⑳, and ㉑.

Compressor (Comp.)**2in/2out**

This is a stereo IN/OUT compressor.

When a signal above the set level is input, it will be compressed before being output. Using the compressor you can effectively remove all signal peaks to eliminate distortion and volume fluctuations during performance, and thus are able to raise the overall volume. In addition, since the overall gain increases when compressing the dynamic range, in which case noise in even the smallest signals becomes audible, this program comes with a noise gate to efficiently reduce such noise. The parameters allow independent settings for left and right channels.

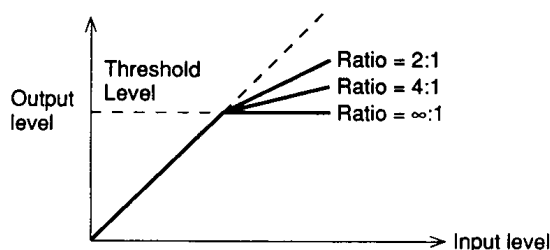

- ① **L.Thrs (Lch Threshold Level: -24 ~ +12)**
This parameter is used to set the level above which Lch input signals will be compressed. If set to a low value, compression will begin at a relatively low level, narrowing the level difference between soft and loud sounds.
- ② **L.Ratio (Lch Ratio: 2:1, 3:1, 4:1, 6:1, 8:1, ∞:1)**
Determines the ratio between the input level (original signal) and the output level (compressed signal) for Lch signals exceeding the threshold level. The higher the value, the higher is the compression; at ∞ :1 signals are compressed to the threshold level.
- ③ **L.Atck (Lch Attack Time: 1.0 ~ 20)**
Determines how long it takes for Lch signals to be compressed fully after compression begins (e.g. the input signal exceeds the threshold level). The shorter the time, the faster compression will take place. If set rather long, compression may be incomplete, creating a unique sound.

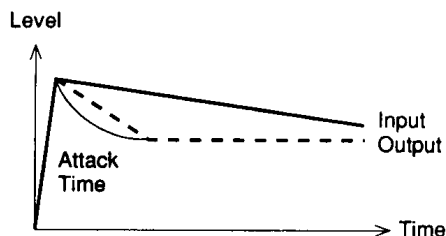

- ④ **L.Rele (Lch Release Time: 0.01 ~ 2.0)**
Determines how soon the compressed signal will be returned to the original signal level after falling below the threshold level.

- ⑤ **L. Gate (Lch Noise Gate Level: 0 ~ 20)**
Determines the minimum level a Lch signal must have to pass through the gate. The gate can be used to eliminate noise when there is no signal input. At a higher noise gate level even louder sound will be cut.
- ⑥ **L.Lvl (Lch Output Level: -∞, -30dB ~ +24dB)**
Determines the Lch level for the following main effect (pre-effect) or the output level (post-effect).
- ⑦ **R.Thrs (Rch Threshold Level: -24 ~ +12)**
- ⑧ **R.Ratio (Rch Ratio: 2:1, 3:1, 4:1, 6:1, 8:1, ∞:1)**
- ⑨ **R.Atck (Rch Attack Time: 1.0 ~ 20)**
- ⑩ **R.Rele (Rch Release Time: 0.01 ~ 2.0)**
- ⑪ **R.Gate (Rch Noise Gate Level: 0.01 ~ 20)**
- ⑫ **R.Lvl (Rch Output Level: -∞, -30dB ~ +24dB)**
These Rch parameters have the same functions as ① through ⑥.

Aural Exciter (AuralX)**2in/2out**

This is a stereo IN/OUT Aural Exciter®. This program artificially adds appropriate harmonics to the input signal, adding luster and effectively bringing “buried” sound to the foreground. Parameters can be set separately for Lch and Rch.

- ① **L.Freq (Lch Frequency: 400Hz ~ 10kHz)**
Determines the cut-off frequency of the Lch’s high pass filter. Harmonic overtones are applied above the set frequency.
- ② **L.Driv (Lch Drive Level: 0 ~ 100)**
Determines the amount of harmonic overtones added to the Lch signal. The harmonic overtones are added only to frequencies higher than L.Freq. The bigger the parameter’s value, the crisper is the sound.
- ③ **L.Mix (Lch Mixing Level: 0 ~ 100)**
This parameter determines the Lch volume balance between the original sound and the effect sound (with overtones). When set to 50%, the original and effect sound volumes are the same. At 0% only the original sound is output.
- ④ **R.Freq (Rch Frequency: 400Hz ~ 10kHz)**
- ⑤ **R.Driv (Rch Drive Level: 0 ~ 100)**
- ⑥ **R.Mix (Rch Mixing Level: 0 ~ 100)**
These Rch parameters have the same functions as ①, ② and ③.
- ⑦ **L.Lvl (Lch Output Level: -∞, -30dB ~ +6dB)**
Determines the Lch level for the following main effect (pre-effect) or the output level (post-effect).
- ⑧ **R.Lvl (Rch Output Level: -∞, -30dB ~ +6dB)**
Determines the Rch level for the following main effect (pre-effect) or the output level (post-effect).

This program is a combination compressor, distortion and 2-band parametric equalizer. Since it is a monaural IN/OUT program, the Lch and Rch inputs are mixed for processing. The processed signal is then separated into Lch and Rch signals for stereo output.

① CmpTyp (Compressor Type: Off, Compr., Limit)

Selects the compressor type:

Compr. : Compresses the dynamic range to even out the sound effect.

Limit. : Compresses peaks to avoid distortion.

Off : No Compression.

② Sustain (Sustain: 0 ~ 100)

Determines the sustain of the sound. The higher the setting, the longer the sound is sustained.

③ Attack (Attack Time: 1.0 ~ 20)

Determines the response time of the compressor. The smaller the value, the sooner compression will begin. To enhance sound with strong attack, such as when picking the guitar, you may want to use a higher setting so that each sound is reproduced with the proper attack when playing fast.

④ CmpLvl (Compressor Level: $-\infty$, -30dB ~ +12dB)

Sets the signal level output to the distortion effect.

⑤ DstTyp (Dist. Type: Dist. 1 ~ Crunch)

Selects the distortion type.

Dist. 1 : Typical distortion sound

Dist. 2 : Mellow distortion sound for Fusion solos etc.

Ovdr. 1 : Typical over-drive sound

Ovdr. 2 : Vacuum tube amplifier over-drive

Crunch : Crunch sound

⑥ Drive (Drive: 0 ~ 100)

Sets the strength of the distortion. The higher the setting, the more distorted the drive is.

⑦ Tone (Tone: -30 ~ +30)

Sets the sound characteristics of the distortion. Higher settings emphasize distortion in the high frequency range, whereas lower settings cut distortion in the high frequency range.

⑧ N.Gate (Noise Gate Level: 0 ~ 20)

Determines the minimum level a signal must have to pass through the noise gate. The gate can be used to eliminate noise when there is no signal input. At a higher noise gate level even louder sound will be cut.

⑨ DstLvl (Dist. Level: $-\infty$, -30dB ~ +6dB)

Sets the signal level output to the 2-band parametric equalizer.

⑩ LowLvl (Low Level: 0 ~ 100)

Determines the amount of boost of the low frequency equalizer. The higher the setting, the more low frequencies will be emphasized.

⑪ LowFrq (Low Frequency: 50Hz ~ 1kHz)

Determines the center frequency of the low frequency equalizer.

⑫ LowQ (Low Q: 0.2 ~ 2.0)

Determines the peak sharpness (steepness) of the low frequency equalizer. The higher the setting, the more the frequency band specified by ⑪ LowFrq is emphasized.

⑬ HigLvl (High Level: 0 ~ 100)

⑭ HigFrq (High Frequency: 400Hz ~ 10kHz)

⑮ HigQ (High Q: 0.2 ~ 2.0)

Set the high frequency equalizer. (Refer to ⑩ ⑪ and ⑫.)

PROGRAM MAIN EFFECT PARAMETERS

In the previous section we have dealt with the pre- and post-effects and their parameters. This section provides you with a detailed description of the various main effects and the parameters controlling them.

The SPX990 comes with 80 preset effect programs which fall into several groups according to their parameters:

REVERB PROGRAMS

- Reverb (Reverb)
 8. CONCERT HALL
 10. VOCAL PLATE
 14. ARENA
- Filtered Reverb (FiltRev)
 1. AMBIENCE
 6. BRIGHT HALL
 7. BREATHY REVERB
 12. PRESENCE REVERB
 13. SNARE PLATE
 16. OLD PLATE
 20. BRIGHT SNARE
 24. STONE ROOM
 26. BLATTY PLATE
 32. DRUM MACH. AMB.L
- Stereo Reverb (St.Rev)
 2. STEREO HALL
 5. VOCAL CHAMBER
 15. THIN PLATE
 31. DRUM MACH. AMB.S
 79. FOREVERVERB
- Echo Room (EchRoom)
 11. ECHO ROOM
 18. WOOD ROOM
 21. SQUASH ROOM
 22. BAMBOO ROOM
 78. TUNNEL

ER (EARLY REFLECTION) PROGRAMS

- Thin Early Reflection (ThinER)
 23. REFLECTIONS
 70. DIST. PERCUSSION
 71. DISTORTION I
- Fat Early Reflection (FatER)
 17. FAT REFLECTIONS
- Gate Reverb (GateRev)
 19. BIG SNARE
 25. CONCRETE ROOM
 27. FULL METAL GATE
 28. HARD GATE
- Reverse Gate (Reverse)
 29. REVERSE GATE
 30. REVERSE PURPLE
 33. ELECT.SNR PLATE

DELAY, ECHO PROGRAMS

- Delay L, C, R (Dly-LCR)
 36. DELAY L, C, R
 76. IRON MAN
- Echo (Echo)
 75. ON THE PHONE
- Multi Tap Delay (Mlt.Tap)
 39. MULTI TAP DELAY
- Stereo Echo (St.Echo)
 40. KARAOKE ECHO
- Tempo Mono Echo (TmpEch1)
 38. 120 BPM MONO DLY
- Tempo Stereo Echo (TmpEch2)
 37. 120 BPM PAN DDL
- Tempo Quad Echo (TmpEch4)
 34. SYNC DELAY

MODULATION PROGRAMS

- Flanger (Flanger)
 65. UP/DOWN FLANGE
 77. RADIO BLAG
- Dual Flanger (DualFlg)
 64. DETUNE CHORUS
- FM. Chorus (FM.Cho)
 62. CLASSY GLASSY
- AM. Chorus (AM.Cho)
 68. ROTARY SP.
- Phaser (Phaser)
 61. STEREO PHASING
 63. SILKY SWEEP
- Symphonic (Symphon)
 57. SYMPHONIC

PITCH CHANGE PROGRAMS

- Mono Pitch Change (MonoPit)
 49. ROGER ON THE 12
 52. INTELLICHORD MON
- Dual Pitch Change (DualPit)
 35. VOICE DOUBLER
 41. GOOD OL.P.CHANGE
 42. VOCAL SHIFT
 43. AIRY PITCH
 44. ANALOGUE SLAP
 46. "LOW" SNARE

47. HALO COMB
 48. GRUMPY FLUTTER
 50. TWISTER
 51. BOTTOM WHACKER
 53. INTELLICHORD DUA
 55. PITCH SLAP
 60. BASS CHORUS
- Triple Pitch Change (TripPit)
 45. FAT BASS
 54. INTELLICHORD TRI
 - Stereo Pitch Change (StPitch)
 56. STEREO PITCH

PAN PROGRAMS

- Auto Pan (Auto Pan)
 67. TREMOLO
 72. PAN
- Triggered Pan (TrigPan)
 73. TRIGGERED PAN

COMPLEX EFFECT PROGRAMS

- Chorus & Reverb (Cho&Rev)
 59. CHORUS & REVERB
- Symphonic & Reverb (Sym&Rev)
 58. GTR SYM ECHO
- Flanger & Reverb (Flg&Rev)
 9. REVERB FLANGE
- Reverb (L) / Reverb (R) (Rev/Rev)
 4. PLATE HALL
- ER (L) / Reverb (R) (ER/Rev)
 3. DRUM CHAMBER
- Echo (L) / Reverb (R) (Ech/Rev)
 80. SILVERHEART
- Chorus (L) / Reverb (R) (Cho/Rev)
 66. UNDERWATER MOON
- Pan (L) / Pan (R) (Pan/Pan)
 74. PAN / PAN

FREEZE PROGRAM

- Freeze (Freeze)
 69. FREEZE

REVERB EFFECTS

Reverberation is the warm musical “ambience” you experience when listening to music in a hall or other properly-designed acoustic environment. “Reverb”, “FiltRev” and “EchRoom” are combined with a gate program controlling the output gate of the reverb by responding to the high and low frequency levels of the input signal. Using this feature you can create gate reverb effects, and also attenuate a signal component before the set RevTime has actually ended.

Main effect name	LCD display	in/out
Reverb	(Reverb)	1in/2out

Parameters

- ① **RevTyp (Reverb Type: Hall, Room, Vocal, Plate)**
- Hall** : Simulates reverberation you would experience in a hall.
 - Room** : Simulates reverberation you would experience in a smaller room.
 - Vocal** : A reverb effect ideally suited for vocals.
 - Plate** : A type of reverberation produced artificially by a plate reverberator.

- ② **RevTime (Reverb Time: 0.3sec ~ 480.0sec)**
 The length of time it takes for the level of reverberation at 1kHz to decrease by +60dB virtually to silence. In a live setting, this depends on several factors: room size, room shape, type of reflective surfaces. The longer the time, the longer it takes for the level of reverberation to decrease to silence.

- ③ **HiRatio (High Ratio: RevTime x0.1 ~ x1.0)**
 Determines the high frequency reverb time in relation to the overall reverb time. Higher values produce longer, high-frequency reverb time, gradually approaching the overall reverb time.

- ④ **IniDly (Initial Delay Time: 0.1msec ~ 200.0sec)**
 This represents the time delay between the direct sound of an instrument in a concert hall and the first of the many reflections that make up reverberation.

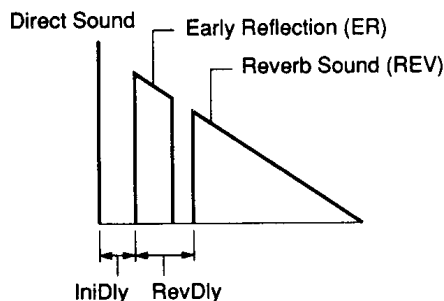

- ⑤ **Diffuse (Diffusion: 0 ~ 10)**
 The complexity of the many reflections that make up reverberation varies according to the shape of the room and its contents. As the value is increased, the complexity of the reflections increases producing a thicker, richer sound.

- ⑥ **Density (Density: 1 ~ 4)**
 This parameter determines the density of the reverb reflections (i.e. the average amount of time between reflections). A setting of 1 produces minimum reverb density for a more spacious sound, while a setting of 4 produces the most dense, “tightest” reverberation.
- ⑦ **RevDly (Reverb Delay Time: 0.1msec ~ 100.0msec)**
 Sets the delay time between the beginning of the early reflections - the initial group of sparse reflections that precede the dense reverb sound and the beginning of the reverb sound.
- ⑧ **Er/Rev (Early Reflection/Reverb Balance: 0% ~ 100%)**
 This parameter determines the level balance between the early-reflection portion and final reverberation portion of the reverb sound. At 100%, only the early-reflection sound will be produced. At 0%, only the final reverberation sound will be produced. A setting of about 50% produces both the early-reflection and final reverberation sounds at an equal level.
- ⑨ **HPF (High Pass Filter Frequency: THRU, 32Hz ~ 1.0kHz)**
 Permits rolling off the low frequency content of the reverb signal below the set frequency. The HPF is OFF when set to THRU.
- ⑩ **LPF (Low Pass Filter Frequency: 1kHz ~ 16kHz, THRU)**
 Permits rolling off the high frequency content of the reverb signal above the set frequency. The LPF is OFF when set at THRU.
- ⑪ **TrgLvl (Trigger Level: 0 ~ 100)**
 Determines the input signal level required to trigger “opening” of the gate. At 100%, only very high input signal levels will trigger the gate. Set the value while inputting the signal.
- ⑫ **TrgDly (Trigger Delay Time: -100.0msec ~ 100.0msec)**
 Determines the time at which the gate actually opens after it has been triggered.
- ⑬ **Hold (Hold Time: 1msec ~ 24000msec)**
 Determines how long the gate stays open, allowing the signal to pass.
- ⑭ **Release (Release Time: 3msec ~ 24000msec)**
 Determines how long it takes for the gate to close fully after the Hold Time has elapsed.
- ⑮ **MidiTrg (MIDI Trigger: ON, OFF) ★**
 When this parameter is set to ON, A KEY ON EVENT message from an external MIDI keyboard can be used to trigger the gate. A KEY ON EVENT message is transmitted whenever a note on a MIDI keyboard is played.

Filtered Reverb (FiltRev)

1In/2out

This is a reverb effect that allows altering the reverb time of the high and low frequency sound.

Parameters

- ① RevTyp (Reverb Type: Hall, Room, Vocal, Plate)
- ② RevTime (Reverb Time: 0.3sec ~ 480.0sec)
- ③ IniDly (Initial Delay Time: 0.1msec ~ 200.0msec)
- ④ Diffuse (Diffusion: 0 ~ 10)
- ⑤ Density (Density: 0 ~ 10)
- ⑥ RevDly (Reverb Delay Time: 0.1msec ~ 100.0msec)
- ⑦ Er/Rev (Early Reflection/Reverb Balance: 0% ~ 100%)
- ⑧ HPF (High Pass Filter Frequency: THRU, 32Hz ~ 1.0kHz)
- ⑨ LPF (Low Pass Filter Frequency: 1kHz ~ 16kHz, THRU)
Same as "Reverb".
- ⑩ LoFrq (Low Control Frequency: 40Hz ~ 1.0kHz)
Determines the cut-off point of the low frequency range for which the reverb time can be changed. The reverb time of frequencies below this point can be set using the "LoGain" parameter.
- ⑪ LoGain (Low Gain: 0.1 ~ 2.4)
Determines the reverb length of frequencies below the "LoFrq" point by multiplying the set "RevTime" by the value set here.
- ⑫ HiFrq (High Control Frequency: 1.0kHz ~ 10kHz)
Determines the cut-off point of the high frequency range for which the reverb time can be changed. The reverb time of frequencies above this point can be set using the "HiGain" parameter.
- ⑬ HiGain (High Gain: 0.1 ~ 2.4)
Determines the reverb length of frequencies above the "HiFrq" point by multiplying the set "RevTime" by the value set here.

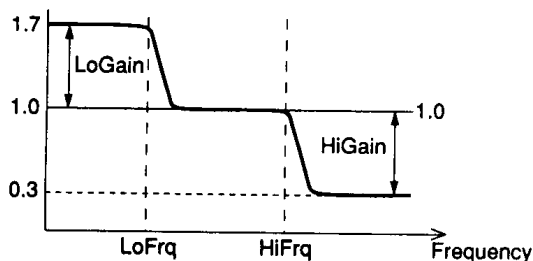

The illustration shows the reverb characteristics for the settings
LoGain = 1.7 and HiGain = 0.3.

- ⑭ TrgLvl (Trigger Level: 0 ~ 100)
- ⑮ TrgDly (Trigger Delay Time: -100.0msec ~ 100.0msec)
- ⑯ Hold (Hold Time: 1msec ~ 24000msec)
- ⑰ Release (Release Time: 3msec ~ 24000msec)
- ⑱ MidiTrg (MIDI Trigger: ON, OFF) ★
Same as "Reverb".

Stereo Reverb (St.Rev)

2In/2out

This reverb program allows mixing of the left and right channel signals for an enhanced ambience effect.

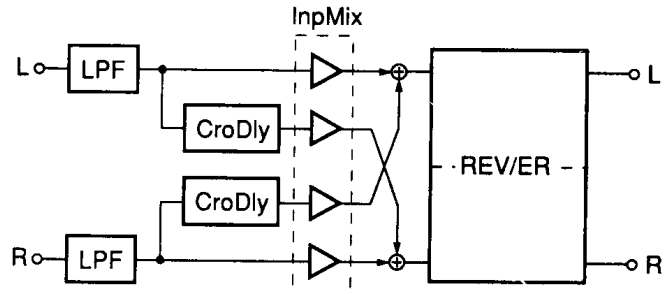
**Parameters**

- ① RevTyp (Reverb Type: Hall, Room, Vocal, Plate)
- ② RevTime (Reverb Time: 0.3sec ~ 480.0sec)
- ③ HiRatio (High Ratio: 0.1 ~ 1.0)
- ④ IniDly (Initial Delay Time: 0.1msec ~ 100.0msec)
Same as "Reverb".
- ⑤ InpMix (Input L-R MIX: 0 ~ 10)
Sets the mixing balance between the inputs of Lch and Rch. When set to "0", Lch and Rch are not mixed. With a setting of "10" both channels are mixed fully, resulting in a monaural signal.
- ⑥ CrsDly (Input Cross Delay: 0.1msec ~ 100.0ms)
Sets the delay time for the delay line inserted at the input stage of the reverb when Lch and Rch are mixed. Changes the depth of the musical "ambience" you experience when listening to music in a hall.
- ⑦ Er/Rev (Early Reflection/Reverb Balance: 0% ~ 100%)
- ⑧ Density (Density: 1 ~ 4)
- ⑨ LPF (Low Pass Filter Frequency: 1kHz ~ 16kHz, THRU)
Same as "Reverb".

Echo Room (EchRoom)**1in/2out**

This is a special type of reverberation in which you have extensive control over the room's dimension and other parameters.

Parameters

- ① Rev Time (Reverb Time: 0.3sec ~ 480.0sec)
- ② HiDump (High Dump: 0.1 ~ 1.0)
Same as "Reverb".
- ③ IniDly (Initial Delay Time: 0.1msec ~ 200.0msec)
This represents the time delay between the direct sound of an instrument in a concert hall and the first of the many reflections that make up reverberation.
- ④ Width (Width: 0.5m ~ 100m)
Specifies the width of the room in meters.
- ⑤ Height (Height: 0.5m ~ 100m)
Specifies the height of the room in meters.
- ⑥ Depth (Depth: 0.5m ~ 100.0m)
Specifies the depth of the room in meters.
- ⑦ WidDec (Width Decay: RevTime x0.1 ~ x10.0)
Determines the characteristics of the "Width" reverb component by multiplying the RevTime by the value set here. This parameter can be used to simulate various wall materials and properties.
- ⑧ HeiDec (Height Decay: RevTime x0.1 ~ x10.0)
- ⑨ DepDec (Depth Decay: RevTime x0.1 ~ x10.0)
These two parameters are very similar to the "WidDec" parameter and allow simulation of ceiling and wall properties.
- ⑩ Wall (Wall Vary: 0 ~ 30)
Allows fine tuning of the wall properties. "0" corresponds to a flat wall, while higher values simulate an increasingly rougher wall surface.
- ⑪ Lis.Pos (Listening Position: FRONT, CENT., REAR)
Sets the imaginary position of the listener.
- ⑫ Diffuse (Diffusion: 0 ~ 10)
- ⑬ Er/Rev (Early Reflection/Reverb Balance: 0% ~ 100%)
- ⑭ RevDly (Reverb Delay Time: 0.1msec ~ 100.0msec)
- ⑮ Density (Density: 0 ~ 4)
- ⑯ HPF (High Pass Filter Frequency: THRU, 32Hz ~ 1.0kHz)
- ⑰ LPF (Low Pass Filter Frequency: 1kHz ~ 16kHz, THRU)
Same as "Reverb".
- ⑱ WidFin (Width Fine: -100 ~ +100)
- ⑲ HeiFin (Height Fine: -100 ~ +100)
- ⑳ DepFin (Depth Fine: -100 ~ +100)
- ㉑ WalFin (Wall Vary Fine: -100 ~ +100)
Sets the "Width", "Height", "Depth" and "Wall" values as default and enables further fine adjustment.
- ㉒ TrgLvl (Trigger Level: 0 ~ 100)
- ㉓ TrgDly (Trigger Delay Time: -100.0msec ~ 100.0msec)
- ㉔ Hold (Hold Time: 1msec ~ 24000msec)
- ㉕ Release (Release Time: 3msec ~ 24000msec)
- ㉖ MidiTrg (MIDI Trigger: ON, OFF) ★
Same as "Reverb".

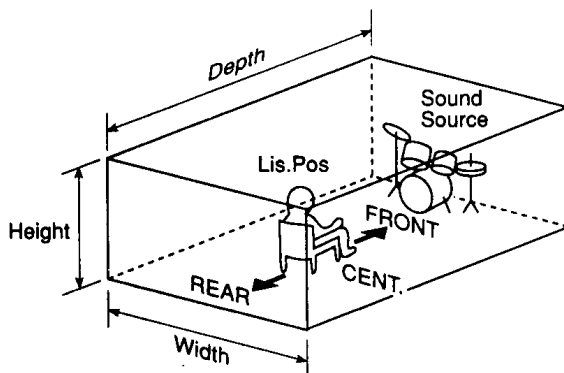

● GATE

The SPX990 can be set to extremely long reverb times (max. 480 seconds). In combination with a “gate”, a long reverb time can be used to shorten a sound or to extract just a short segment of a longer input signal. While the “GateRev” effect of the ER EFFECTS applies its gate to early reflections, the REVERB EFFECTS (pages 25 to 27) apply their gate to the reverberation to cut the reverb sound, which results in a sound different from the ER effect. In this way the combination of gate and reverb can be used for a number of purposes. A gate is a kind of switch that determines when a signal can pass. The signal will pass after the gate opens and is cut when the gate closes.

TRIGGER

A gate can be opened by various triggers. Usually the strength of the input signal is used as a trigger. When the input signal exceeds a certain level (trigger level) the gate opens and the signal can pass. As soon as the signal level falls below the trigger level, the gate closes and the sound is cut. The trigger level is set using the TrgLvl parameter.

Hold and Release

A short input signal like the one shown in the figure below would cause the gate to be open only for a very short time while the signal level is above the trigger level (TrgLv). By setting a long Hold time the gate can be kept open even after the signal level has gone below the trigger level. Also, if the gate closes abruptly, an unnatural sound results. To avoid this, the Release parameter can be used to specify a time during which the gate will close gradually after the Hold time has elapsed.

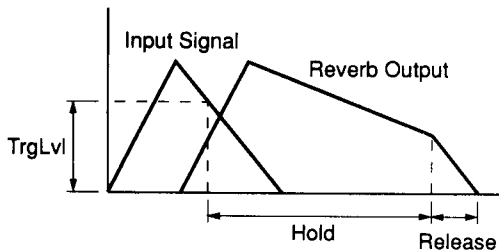

OTHER TRIGGERS

The signal level is not the only way to trigger the gate. A foot switch connected to the TRIGGER terminal on the rear panel or a MIDI NOTE ON message can also be used. The set Hold and Release times work with any trigger.

- * To use a MIDI trigger, MidiTrg must be set to ON.
- * When TrgLvl is set to 100, the gate will not be triggered by even the highest input signal levels, but will respond to foot switch and MIDI triggers.

TrgDly

When TrgDly is set to 0, the gate opens after the initial delay when the input signal exceeds the trigger level. If set to a value larger than 0, the gate opens after the initial delay time has ended.

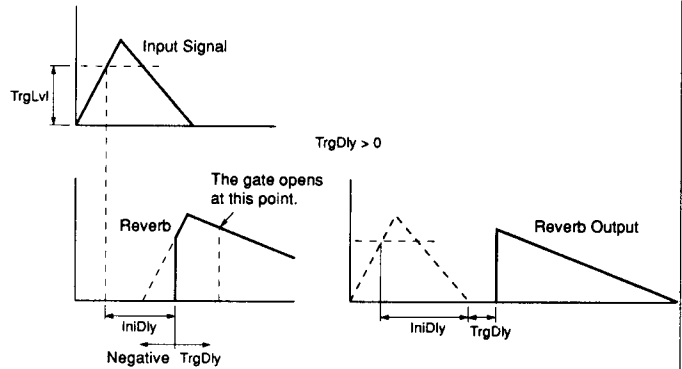

When TrgDly is set to a negative value, the gate will open before the initial delay. This is useful for input signals with slow attack.

If a negative value is set whose absolute value is larger than that of the initial delay, the gate will open even before the signal level exceeds the trigger level.

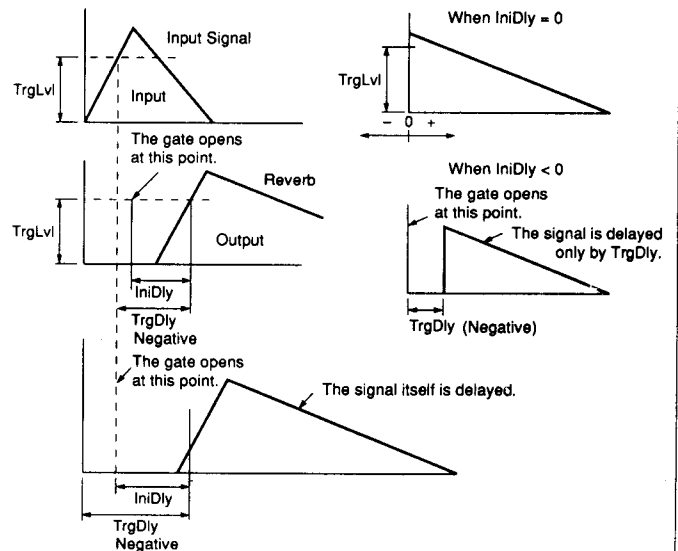

NOTE: When TrgLvl is set to 0, the gate will always remain open. In this case, triggering by other sources (foot switch, MIDI NOTE ON) is not possible.

If the gate is continuously triggered by any of the other sources, it may be kept from closing. As the gate responds to any trigger source and will open for the set hold time, a trigger received while the gate is open will act as a “re-trigger”, causing the gate to remain open.

ER (EARLY REFLECTION) EFFECTS

ER effects are created using different groupings of “Early Reflections” – the first cluster of reflections that occurs after the direct sound but before the dense reflections that are known as reverberation begin. This produces interesting results for drums, percussion, guitar, brass and some other instruments.

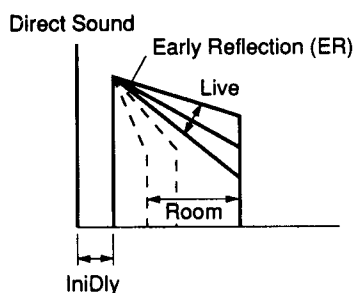

Thin Early Reflection (ThinER)	1in/2out
---------------------------------------	-----------------

Fat Early Reflection (FatER)	1in/2out
-------------------------------------	-----------------

The “ThinER” effect has a low density whereas the “FatER” effect has dense early reflections.

Gate Reverb (GateRev)	1in/2out
------------------------------	-----------------

The gate reverb program combines reverb with a ‘gate’ that has programmable threshold and release time parameters. All other parameters are the same as those for the Reverb effect.

Reverse Gate (Reverse)	1in/2out
-------------------------------	-----------------

This program reverses the gated effect.

Parameters:

① ErType (Early Reflection Type)

Selects the ER pattern. Since the sound level depends on the pattern, this parameter sets an important base for editing a program.

[ThinER]

[FatER]

S-Hall (SmallHall), L-Hall (Large Hall), Random, Reverse, Plate, Spring

[GateRev]

Type-A, Type-B

[Reverse]

Type-A, Type-B

② Room (Room Size: 0.1 ~ 25.0)

This parameter sets the time intervals between the early reflections and a feature of natural early reflections which is directly proportional to the size of the room.

③ Live (Liveness: 0 ~ 10)

“Liveness” refers to the rate at which the reflected sounds fade. An acoustically “dead” room is simulated by setting this parameter to zero. Increasing the value of this parameter creates an increasing “live” sound, simulating an increasing area of reflective surfaces in the room.

④ Diffuse (Diffusion: 0 ~ 10)

Determines the clearness of the sound. As the value is increased, the complexity of the reflections increases producing a thicker and richer sound.

⑤ IniDly (Initial Delay Time: 0.1msec ~ 400msec)

Initial delay is the time between the beginning of the direct sound and the beginning of the early reflection.

⑥ HPF (High Pass Filter Frequency: THRU, 32Hz ~ 1.0kHz)

Permits rolling off the low frequency content of the reverb signal above the set frequency. The HPF is OFF when set to THRU.

⑦ LPF (Low Pass Filter Frequency: 1.0kHz ~ 16kHz, THRU)

Permits rolling off the high frequency content of the reverb signal below the set frequency. The LPF is OFF when set to THRU.

⑧ Er Number (Early Reflection Number: 1 ~ 19)

This parameter directly sets the number of early reflections produced from 1 to 19.

⑨ FbDly (Feed Back Delay Time: 0.1msec ~ 900msec)

Sets a delay time between the beginning of the original early reflections and the first of the repeats caused by feedback. Shorter FbDly times simply thicken the early reflection sound while longer FbDly times can create extended or repeated early reflection effects.

⑩ FbGain (Feed Back Gain: -99% ~ +99%)

This parameter determines how many times (for how long) the early reflections are repeated. The lower the setting, the fewer repeats occur.

⑪ FbHigh (High Frequency Feed Back Gain: 0.1 ~ 1.0)

This parameter determines how much of the high frequency content of the original early reflections is fed back. The lower the setting, the less of the original high frequencies are fed back. This causes a gradual decrease in high frequency content at each repeat.

⑫ Density (Density: 0 ~ 3, “FatER” effect 1 ~ 3)

This parameter determines the density of the reverb reflections (i.e. the average amount of time between reflections.) A setting of 0 or 1 produces minimum reverb density for a more spacious sound, while a setting of 3 produces the most dense, “tightest” reverberation. There is no density parameter for “ThinER”.

DELAY, ECHO EFFECTS

Delay L, C, R (Dly-LCR)

1in/2out

These sophisticated delay effects offer independently variable left, center and right channel delays. There are two types of feed back stereo delays.

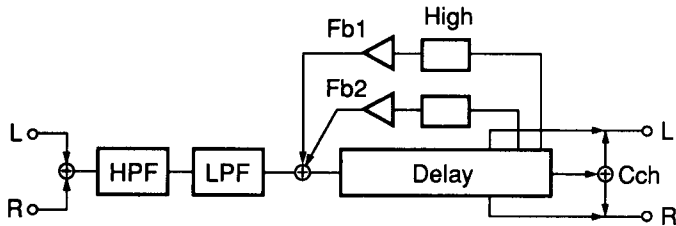

Parameters

- ① L.Dly (Lch Delay Time: 0.1msec ~ 1480.0msec)
- ② R.Dly (Rch Delay Time: 0.1msec ~ 1480.0msec)
- ③ C.Dly (Center ch Delay Time: 0.1msec ~ 1480msec)
These parameters individually set the time between the direct sound of the instrument and the first repeat heard from the left, right and center channels.
- ④ C.Lvl (Center Channel Delay Level: -200% ~ +200%)
Adjusts the level of the center-channel delay signal. A minus value produces a reversed phase.
- ⑤ Fb1Dly (FeedBack 1 Delay Time: 0.1msec ~ 1480msec)
Feedback refers to the repeated pattern of 3 delay signals. The diagram below shows an interval setting for the repeated pattern. You can choose between 2 feedback patterns and the diagram below shows 1 form of feedback. Fb1Dly is the delay time between 2 feedbacks.

Direct Sound

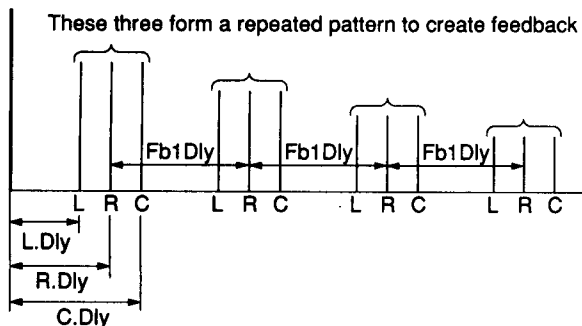

- ⑥ Fb1Gain (Feed Back 1 Gain: -99% ~ +99%)

Sets the amount of the Fb1 delay signal fed back to the input of the processor. The higher the feedback gain setting, the greater the number of delayed repeats produced by the corresponding feedback loop.

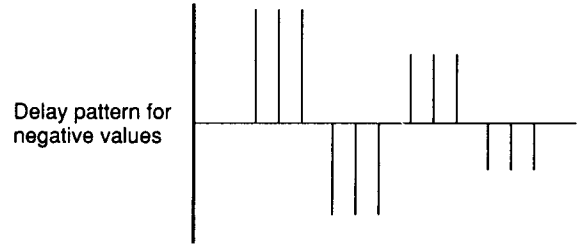

- ⑦ Fb2Dly (Feed Back 2 Delay Time: 0.1msec ~ 1480.0msec)
- ⑧ Fb2Gain (Feed Back 2 Gain: -99% ~ +99%)

Sets the amount of the Fb2 delay signal fed back to the input of the processor. The higher the feedback gain setting, the greater the number of delayed repeats produced by the corresponding feedback loop.

Direct Sound

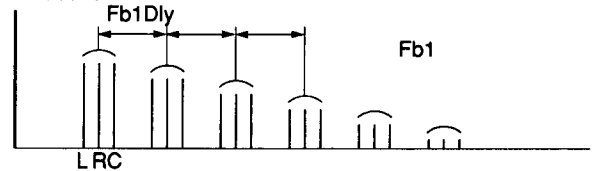

Direct Sound

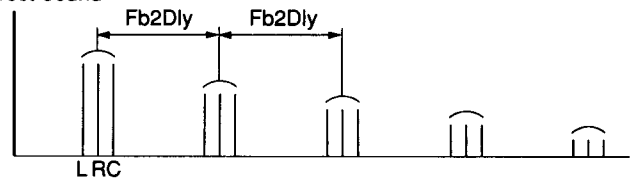

NOTE: Since the effect is influenced by Fb1 and Fb2, the interference of Fb1 and Fb2 creates an interesting sound.

NOTE: Do not set the gains of Fb1 and Fb2 higher than 100%.

- ⑨ High (High Frequency Feed Back Gain: 0.1 ~ 1.0)
Controls feedback Fb1 and Fb2 in the high frequency range. The high frequency feedback is reduced as the value of this parameter is decreased.
- ⑩ HPF (High Pass Filter Frequency: THRU, 32Hz ~ 1.0kHz)
Permits rolling off the low frequency contents of the reverb signal below the set frequency. The HPF is OFF when set to THRU.
- ⑪ LPF (Low Pass Filter Frequency: 1.0kHz ~ 16kHz, THRU)
Permits rolling off high frequency content of the reverb signal above the set frequency. The LPF is OFF when set to THRU.

Echo (Echo)**1in/2out**

The echo effect offers independently variable left and right echo intervals.

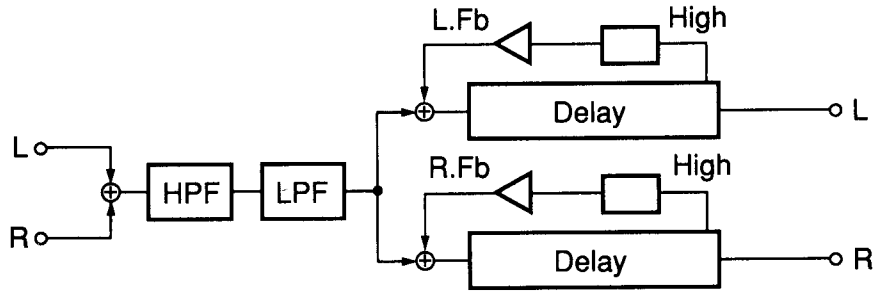
**Parameters**

- ① **L.FbDly (Lch Feed Back Delay: 0.1msec ~ 740.0msec)**
Sets the time between subsequent echo sounds from the left channel.
- ② **L.Fb (Lch Feed Back Gain: -99% ~ +99%)**
Set the amount of the left channel echo signal fed back to the left channel input of the processor. The lower the feedback gain setting, the smaller the number of echo repeats produced by the feedback loop.
- ③ **R.FbDly (Rch Feed Back Delay: 0.1msec ~ 740.0msec)**
Sets the time between subsequent echo sounds from the right channel.
- ④ **R.Fb (Rch Feed Back Gain: -99% ~ +99%)**
Sets the amount of the right channel echo signal fed back to the right channel input of the processor. The higher the feedback gain setting, the greater the number of echo repeats produced by the feedback loop.
- ⑤ **High (High Frequency Feed Back Gain: x0.1 ~ x1.0)**
Controls feedback amount of L.Fb and R.Fb in the high frequency range. Sets the amount of the left channel echo signal to be fed back to the left channel input of the processor. The lower the feedback gain setting, the smaller the number of echo repeats produced by the feedback loop.
- ⑥ **L.InDly (Lch Initial Delay: 0.1msec ~ 740.0msec)**
- ⑦ **R.InDly (Rch Initial Delay: 0.1msec ~ 740.0msec)**
These parameters individually set the time between the direct sound of the instrument and the first repeat heard from the left and right channel.
- ⑧ **HPF (High Pass Filter Frequency: THRU, 32Hz ~ 1.0kHz)**
Permits rolling off the low frequency content of the reverb signal below the set frequency. The HPF is OFF when set to THRU.
- ⑨ **LPF (Low Pass Filter Frequency: 1.0kHz ~ 16kHz, THRU)**
Permits rolling off the high frequency content of the reverb signal above the set frequency. The LPF is OFF when set to THRU.

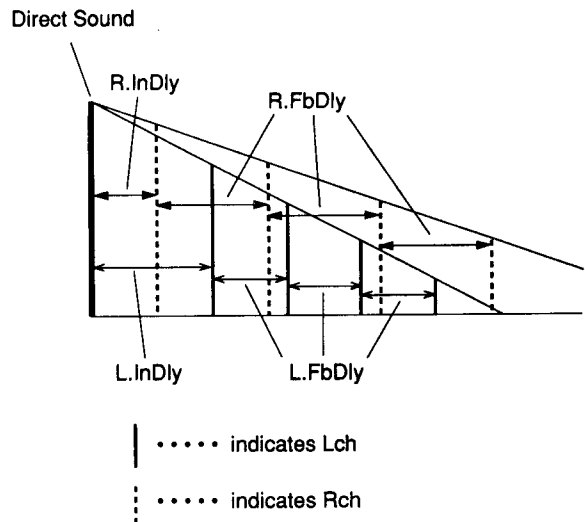

Multi Tap Delay (Mit. Tap)

1in/2out

This is a multi-tap delay effect in which the time, stereo position and level of up to 6 separate delays can be programmed individually.

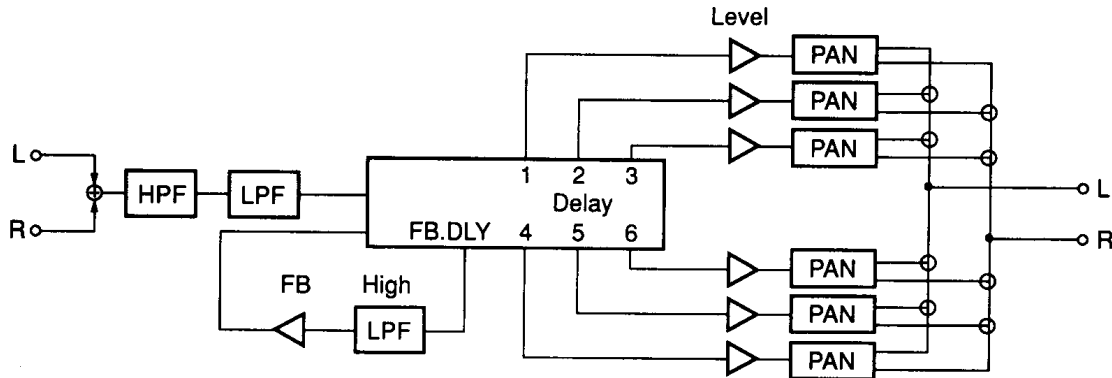
**Parameters**

- ① **Delay1 (Delay1: 0.1msec ~ 1480.0msec)**
The first delay time. The time when the first tap delay sound occurs.
- ② **Level1 (Level1: -100% ~ +100%)**
The output level of the first tap delay sound. A minus value produces a reverse-phase delay sound.
- ③ **Pan1 (Pan1: 100/0 ~ 0/100)**
Sets the stereo position of this first tap delay sound. A setting at 100/0 positions the sound all the way to the left. 0/100 moves the sound to the right and 50/50 positions it at the center.
- ④ **Delay2 (Delay2: 0.1msec ~ 1480.0msec)**
- ⑤ **Level2 (Level2: -100% ~ +100%)**
- ⑥ **Pan2 (Pan2: 100/0 ~ 0/100)**
Set the second tap delay sound.
- ⑦ **Delay3 (Delay3: 0.1msec ~ 1480.0msec)**
- ⑧ **Level3 (Level3: -100% ~ +100%)**
- ⑨ **Pan3 (Pan3: 100/0 ~ 0/100)**
Set the third tap delay sound.
- ⑩ **Delay4 (Delay4: 0.1msec ~ 1480.0msec)**
- ⑪ **Level4 (Level4: -100% ~ +100%)**
- ⑫ **Pan4 (Pan4: 100/0 ~ 0/100)**
Set the fourth tap delay sound.
- ⑬ **Delay5 (Delay5: 0.1msec ~ 1480.0msec)**
- ⑭ **Level5 (Level5: -100% ~ +100%)**
- ⑮ **Pan5 (Pan5: 100/0 ~ 0/100)**
Set the fifth tap delay sound.
- ⑯ **Delay6 (Delay6: 0.1msec ~ 1480.0msec)**
- ⑰ **Level6 (Level6: -100% ~ +100%)**
- ⑱ **Pan6 (Pan6: 100/0 ~ 0/100)**
Set the sixth tap delay sound.
- ⑲ **FbDly (Feed Back Delay Time: 0.1msec ~ 1480msec)**
Sets the time until the feedback delay sound occurs.
- ⑳ **FbGain (Feed Back Gain: -99% ~ 99%)**
Sets the output level of the feedback delay sound.
- ㉑ **High (High Frequency Feed Back Gain: x0.1 ~ x1.0)**
Sets the cut-off frequency for the high frequency content of the feedback signal.
- ㉒ **HPF (High Pass Filter Frequency: THRU, 32Hz ~ 1.0kHz)**
Permits rolling off the low frequency content of the reverb signal below the set frequency. The HPF is OFF when set to THRU.
- ㉓ **LPF (Low Pass Filter Frequency: 1.0kHz ~ 16kHz, THRU)**
Permits rolling off the high frequency content of the reverb signal above the set frequency. The LPF is OFF when set to THRU.

Stereo Echo (St. Echo)**2In/2out**

The stereo echo effect offers independently variable left and right channel initial delays and echo intervals.

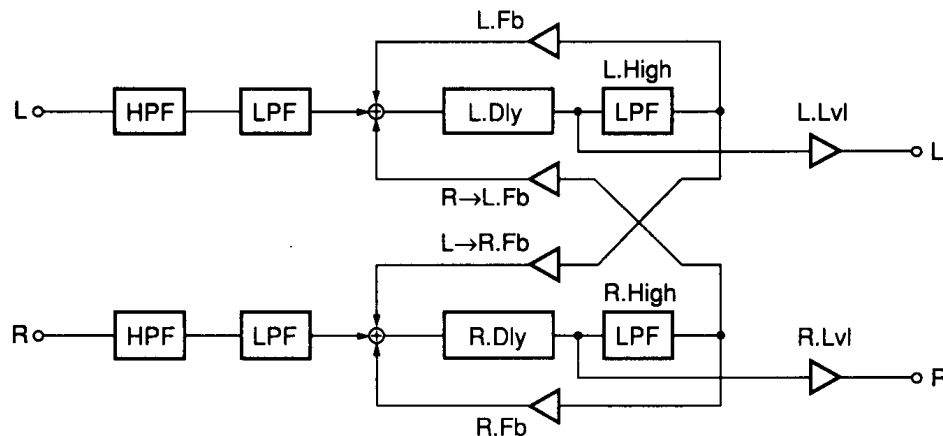
**Parameters**

- ① **L.Dly (Lch Feed Back Delay: 0.1msec ~ 740.0msec)**
Sets the time between the echo sound and the first repeat heard from the left channel.
- ② **L.Fb (Lch Feed Back Gain: -99% ~ +99%)**
Sets the amount of the left channel echo signal fed back to the left channel input of the processor. The lower the feedback gain setting, the smaller the number of echo repeats produced for the left channel.
- ③ **L.Lvl (Lch Level: -100% ~ +100%)**
Sets the output level of the echo sound from the left channel.
- ④ **R.Dly (Rch Feed Back Delay: 0.1msec ~ 740.0msec)**
Sets the time between the echo sound and the first repeat from the right channel.
- ⑤ **R.Fb (Rch Feed Back Gain: -99% ~ 99%)**
Sets the amount of the right channel echo signal fed back to the right channel input of the processor. The lower the feedback gain setting, the smaller the number of delayed repeats produced for the right channel.
- ⑥ **R.Lvl (Rch level: -100% ~ 100%)**
Sets the output level of the echo sound from the right channel.
- ⑦ **L → R.Fb (L → R Cross Feed Back: -99% ~ +99%)**
Sets the amount of echo sound fed back from the left channel output to the right channel input.
- ⑧ **R → L.Fb (R → L Cross Feed Back: -99% ~ +99%)**
Sets the amount of echo sound fed back from the right channel output to the left channel input.
- ⑨ **L.High (Lch High Frequency Feed Back Gain: x0.1 ~ x1.0)**
Controls high frequency feedback from the output of the left channel processor to the input of the right channel processor. The high frequency feedback is reduced as the value of this parameter is decreased.
- ⑩ **R.High (Rch High Frequency Feed Back Gain: x0.1 ~ x1.0)**
Controls high frequency feedback from the output of the right channel processor to the input of the left channel processor. The high frequency feedback is reduced as the value of this parameter is decreased.
- ⑪ **HPF (High Pass Filter Frequency: THRU, 32Hz ~ 1.0kHz)**
Permits rolling off the low frequency content of the reverb signal below the set frequency. The HPF is OFF when set to THRU.
- ⑫ **LPF (Low Pass Filter Frequency: 1.0kHz ~ 16kHz, THRU)**
Permits rolling off the high frequency content of the reverb signal above the set frequency. The LPF is OFF when set at THRU.

NOTE: Be careful not to set the feedback parameters ②, ⑤, ⑦ and ⑧ too high as this might result in oscillation interference.

The delay time of the following three effects is determined by the "Tempo" and "Note" parameters, so you can easily match the delay time to the tempo of the music.

Tempo Mono Echo (TmpEch1) **1in/2out**

Creates a single delay with stereo output.

Tempo Stereo Echo (TmpEch2) **2in/2out**

Produces a separately processed left and right channel stereo echo.

Tempo Quad Echo (TmpEch4) **2in/2out**

This program produces an echo effect that used to be possible only with four delay effect machines. Four delay lines are controlled in pairs.

● How to input the "TEMPO" parameter

One of the following five methods can be used to input the "Tempo" parameter.

• Manual Input

You can set the Tempo like any other parameter by inputting a numerical value in the edit mode.

• Tap Input (Function Key)

The tempo can also be set by pressing a function key twice in succession in the edit mode. The interval between the two key operations determines the Tempo value.

• Tap Input (Footswitch)

Instead of a function key, a foot switch connected to the rear-panel TRIGGER terminal can also be pressed twice in succession.

• MIDI Clock Input

The Tempo value may also be set using the MIDI clock of a connected device.

• MIDI Control Change

The Tempo parameter can also be controlled via MIDI control change messages like any other parameter.

The input methods available depend on the setting of the "Trig." parameter.

SETTING OF "Trig." PARAMETER	OFF	TAP	MIDI
MANUAL INPUT	○	○	○
TAP INPUT (FUNCTION KEY)	×	○	×
TAP INPUT (FOOT SWITCH)	×	○	×
MIDI CLOCK INPUT	×	×	○
MIDI CONTROL CHANGE	○	○	○

● TAP INPUT

You can set the delay time following the tempo of the music by pressing a function key or a connected foot switch twice in succession. To set a delay time matching the tempo of the music, you just press the foot switch twice for a one-beat interval. This eliminates a troublesome parameter setting in the edit mode.

What you actually set by tap input is not the delay time but the tempo. The delay time then is calculated based on this Tempo value and the Note value, which must be set in advance.

When you tap input using the "TapKey" display, a bar graph indication shows the time elapsed since the first function key or foot switch operation. One bar equals 250 msec (50 msec per vertical line). Please note that the bars will disappear, if the maximum allowable delay time is exceeded before you press the function key or foot switch a second time.

• Tap Input using a function key

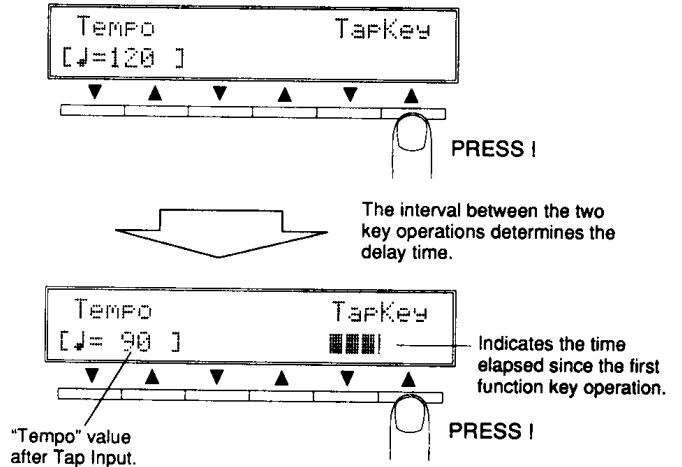

• Tap Input by Foot Switch

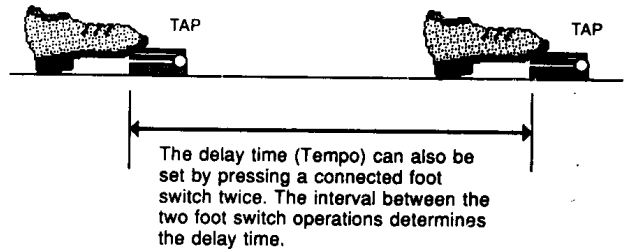

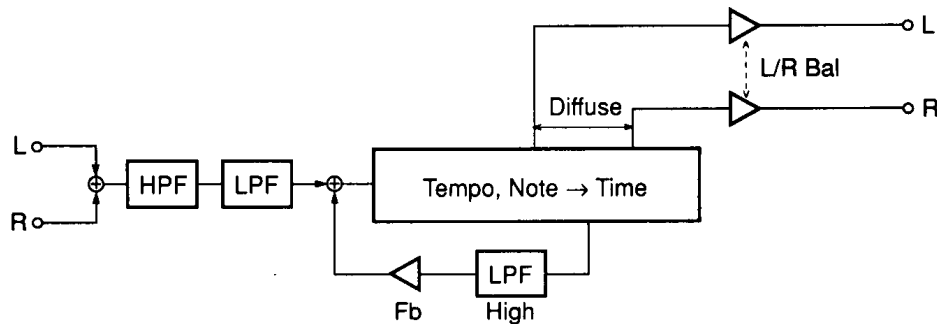

Parameters

- ① **Tempo (Tempo: ♩ = 41 ~ 250)**
Indicates the number of quarter notes per minute (beats/minute).
 - ② **Note (Note: ♩, ♪, ♫, ♮, ♯, ♭, ♮, ♩)**
Sets the duration of sound by note. The delay time will be calculated based on this Note value and the Tempo setting. The delay value then is displayed as "Time" (No. ③).
 - ③ **Time (Time: ±10msec)**
Displays the delay time calculated from the Note and Tempo settings. The displayed value can be varied in the range of ±10 msec.
As long as the delay time value is not changed, "=" will be displayed in front of the parameter name. If you decrease the value, a "+" is displayed, and if a higher value is set, a "-".
- NOTE: The Time value will remain in memory even if you change the Tempo and Note settings.
- ④ **FbGain (Feed Back Gain: -99 ~ +99)**
Sets the output level of the feedback delay sound.
 - ⑤ **High (High Frequency Feed Back Gain: x0.1 ~ x1.0)**
Controls the feedback amount in the high frequency range. Sets the amount of delay sound to be fed back to the input of the processor. The lower the feedback gain setting, the smaller the number of delay repeats produced by the feedback loop. A minus value produces a reversed phase.
 - ⑥ **Diffuse (Diffusion: 0 ~ 10)**
Controls the loudness and clearness of the sound. As the diffusion value is increased, a thicker and richer sound is produced.
 - ⑦ **L/R Bal (Lch/Rch Balance: 100/00 ~ 00/100)**
Sets the sound balance between the left and right channels. A setting of 100/0 positions the sound all the way to the left, while 0/100 positions it to the right and 50/50 in the center. This parameter can be used conveniently to correct a delay sound shift which can occur when a high Diffuse parameter value is set. The parameter also allows positioning of the delay sound anywhere in the stereo sound field.
 - ⑧ **Trig. (Trigger: OFF, TAP, MIDI)**
Selects the input method for the Tempo parameter setting. (Refer to page 34.)
 - ⑨ **Tempo (Tempo: ♩ = 41 ~ 250)**
Indicates the Tempo value input using "TapKey" (function switch), foot switch or MIDI.
 - ⑩ **TapKey ★**
Is indicated when you set the Tempo parameter by tap input using the function keys. The tempo is set by pressing one of the function keys (▼ or ▲) under "TapKey" twice.
 - ⑪ **HPF (High Pass Filter Frequency: THRU, 32Hz ~ 1.0kHz)**
Permits rolling off the low frequency content of the reverb signal below the set frequency. The HPF is OFF when set at THRU.
 - ⑫ **LPF (Low Pass Filter Frequency: 1.0kHz ~ 16kHz, THRU)**
Permits rolling off the high frequency content of the reverb signal above the set frequency. The LPF is OFF when set to THRU.

Tempo Stereo Echo (TmpEch2)

2In/2out

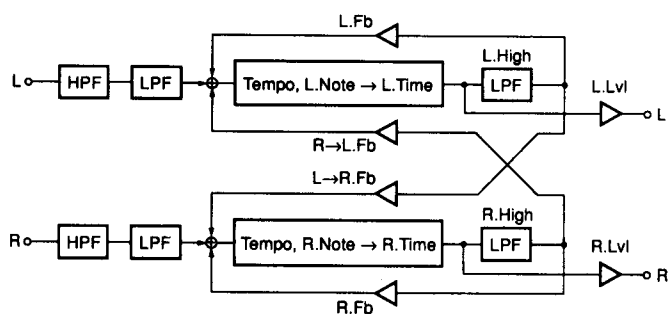

Parameters

- ① Tempo (Tempo: ♩ = 82 ~ 250)
- ② L.Note (Lch Note: ♩, ♪, ♫, ♬, ♭, ♮, ♯, ♯, ♯)
- ③ R.Note (Rch Note: ♩, ♪, ♫, ♬, ♭, ♮, ♯, ♯, ♯)
- ④ L.Time (Lch Time: ±10msec)
- ⑤ R.Time (Rch Time: ±10msec)
- ⑥ L.Lvl (Lch Level: -100% ~ +100%)
- ⑦ R.Lvl (Rch Level: -100% ~ +100%)
- ⑧ LFb (Lch Feed Back Gain: -99% ~ +99%)
- ⑨ R.Fb (Rch Feed Back Gain: -99% ~ +99%)
- ⑩ L → R.Fb (L → R Cross Feed Back: -99% ~ +99%)
- ⑪ R → L.Fb (R → L Cross Feed Back: -99% ~ +99%)
- ⑫ L.High (Lch High Frequency Feed Back Gain: x0.1 ~ x1.0)
- ⑬ R.High (Rch High Frequency Feed Back Gain: x0.1 ~ x1.0)
- ⑭ Trig. (Trigger: OFF, TAP, MIDI)
- ⑮ Tempo (Tempo: ♩ = 82 ~ 250)
- ⑯ TapKey ★
- ⑰ HPF (High Pass Filter Frequency: THRU, 32Hz ~ 1.0kHz)
- ⑱ LPF (Low Pass Filter Frequency: 1.0kHz ~ 16kHz, THRU)

NOTE: The delay time of this effect is determined by the Tempo, Note and Time settings, as described for the "TmpEch1" effect (page 35). For an explanation of the other parameters see "St.Echo" effect on page 33.

NOTE: Be careful not to set the feedback parameters ⑧ to ⑪ too high as this might result in oscillation interference.

Tempo Quad Echo (TmpEch4)

2In/2out

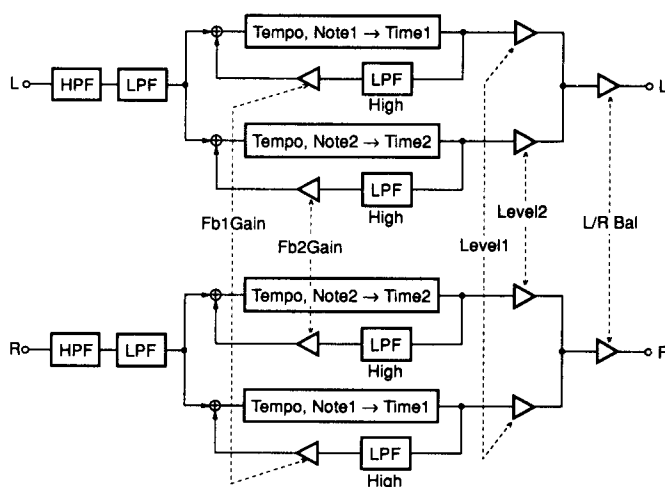

Parameters

- ① Tempo (Tempo: ♩ = 82 ~ 250)
- ② Note1 (Note 1: ♩, ♪, ♫, ♬, ♭, ♮, ♯, ♯, ♯)
- ③ Note2 (Note 2: ♩, ♪, ♫, ♬, ♭, ♮, ♯, ♯, ♯)
- ④ Time1 (Time 1: ±5msec)
- ⑤ Time2 (Time 2: ±5msec)
- ⑥ Diffuse (Diffusion: 0 ~ 10)
- ⑦ Level1 (Level 1: -100% ~ +100%)
- ⑧ Level2 (Level 2: -100% ~ +100%)
- ⑨ L/R Bal (Lch/Rch Balance: 100/00 ~ 00/100)
- ⑩ Fb1Gain (Feed Back 1 Gain: -99% ~ +99%)
- ⑪ Fb2Gain (Feed Back 2 Gain: -99% ~ +99%)
- ⑫ High (High Frequency Feed Back Gain: x0.1 ~ x1.0)
- ⑬ Trig. (Trigger: OFF, TAP, MIDI)
- ⑭ Tempo (Tempo: ♩ = 82 ~ 250)
- ⑮ TapKey ★
- ⑯ HPF (High Pass Filter Frequency: THRU, 32Hz ~ 1.0kHz)
- ⑰ LPF (Low Pass Filter Frequency: 1.0kHz ~ 16kHz, THRU)

NOTE: Note1 and Note2 are set in the same way as described for the "TmpEch1" effect. For a detailed explanation of each parameter see "TmpEch1" effect on page 35.

NOTE: Be careful not to set the feedback parameters ⑧ to ⑪ too high as this might result in oscillation interference.

MODULATION EFFECTS

Mixing sounds with slightly varied delay times results in tone alterations due to mutual phase interference. In addition, the delay time and delay sound level can be modulated using the LFO, resulting in further tone alteration over time.

Flange (Flanger)	2in/2out
Dual Flange (DualFig)	2in/2out

The flanging effect is produced by varying the delay between 2 identical signals, thus producing a complex varying “Comb Filter” effect.

Parameters

- ① **ModFrq (Modulation Frequency: 0.05Hz ~ 40.0Hz)**
Sets the speed of modulation, and hence the rate at which the effect varies.
- ② **Depth (1, 2)(Modulation Depth: 0% ~ 100%)**
Sets the amount of delay time variation, thus adjusting the depth of the effect. A bigger value will give at deeper modulation.
- ③ **Delay (1, 2)(Modulation Delay Time: 0.1msec ~ 100.0msec)**
Sets the basic delay time from the initial direct sound to the beginning of the flange effect. A setting of 1.0msec and below causes interference in the high frequency range.
- ④ **Phase (Phase: -180.0deg ~ +180.0deg)**
Sets the phase between Modulation Delay 1 and 2.
- ⑤ **FbGain (Feed Back Gain: 0% ~ 99%)**
Determines the amount of flange signal fed back to the input of the processor for further modulation. More feedback increases the overall complexity, “strength” and decay time of the effect.
- ⑥ **InMode (Input Mode: Mix, Stereo)**
Selects the input mode for processing of a mixed left and right channel signal (Mix) or separate left and right channel signals (Stereo).
- ⑦ **HPF (high Pass Filter Frequency: THRU, 32Hz ~ 1.0kHz)**
Permits rolling off the low frequency content of the reverb signal below the set frequency. The HPF is OFF when set to THRU.
- ⑧ **LPF (Low Pass Filter Frequency: 1.0kHz ~ 16kHz, THRU)**
Permits the rolling off the high frequency content of the reverb signal above the set frequency. The LPF is OFF when set at THRU.

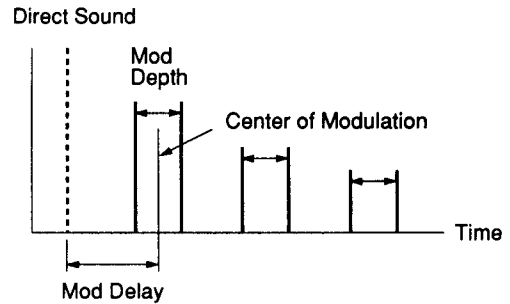

FM Chorus (FM.Cho)**2in/2out**

The chorus effect combines delay time and amplitude modulation to effectively thicken and add warmth to the sound.

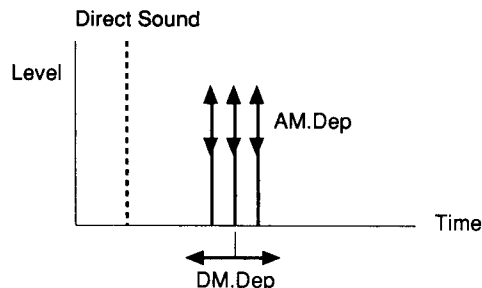
**Parameters**

- ① **ModFrq (Modulation Frequency: 0.05Hz ~ 40.0Hz)**
Sets the speed of modulation, and hence the rate at which the chorus effect varies.
- ② **DM.Dep (Delay Time Modulation Depth: 0% ~ 100%)**
Sets the amount of delay time variation between Lch and Rch, thus adjusting the depth of the effect.
- ③ **AM.Dep (Amplitude Modulation Depth: 0% ~ 100%)**
Sets the depth of amplitude modulation. Higher values produce deeper amplitude modulation.
- ④ **InMode (Input Mode: Mix, Stereo)**
Selects the input mode for processing of a mixed left and right channel signal (Mix) or separate left and right channel signals (Stereo).
- ⑤ **HPF (High Pass Filter Frequency: THRU, 32Hz ~ 1.0kHz)**
Sets the cutoff frequency of the high pass filter. The HPF is OFF when set to THRU.
- ⑥ **LPF (Low Pass Filter Frequency: 1.0kHz ~ 16kHz, THRU)**
Sets the cutoff frequency of the low pass filter. The LPF is OFF when set to THRU.

AM Chorus (AM.Cho)**2in/2out**

This effect adds more modulation variations to the sound than FM.Cho effect.

Parameters

- ① **ModFrq (Modulation Frequency: 0.05Hz ~ 40.0Hz)**
- ② **Depth (Delay Time Modulation Depth: 0% ~ 100%)**
- ③ **InMode (Input Mode: Mix, Stereo)**
- ④ **HPF (High Pass Filter Frequency: THRU, 32Hz ~ 1.0kHz)**
- ⑤ **LPF (Low Pass Filter Frequency: 1.0kHz ~ 16kHz, THRU)**

NOTE: For a detailed explanation of each parameter see "Flanger" effect on page 37.

Phaser (Phaser)**2in/2out**

This is an excellent simulation of the traditional "phaser" effect, producing a gentle phase-shift sound that can be used to add extra animation to a wider range of source signals.

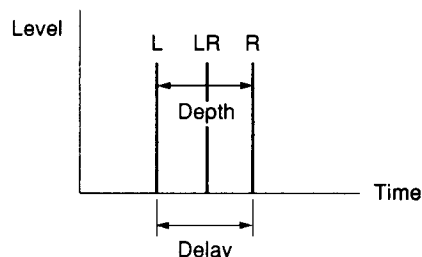
**Parameters**

- ① **ModFrq (Modulation Frequency: 0.05Hz ~ 40.0Hz)**
- ② **Depth (Delay Time Modulation Depth: 0% ~ 100%)**
- ③ **Delay (Modulation Delay Time: 0.1msec ~ 5.0msec)**
- ④ **InMode (Input Mode: Mix, Stereo)**
- ⑤ **HPF (High Pass Filter Frequency: THRU, 32Hz ~ 1.0kHz)**
- ⑥ **LPF (Low Pass Filter Frequency: 1.0kHz ~ 16kHz, THRU)**

NOTE: For a detailed explanation of each parameter see "Flanger" effect on page 37.

Symphonic (Symphon)**2in/2out**

This broad sweep effect adds a sense of scale to the sound than the "FM.Cho" effect.

Parameters

- ① **ModFrq (Modulation Frequency: 0.05Hz ~ 40.0Hz)**
- ② **Depth (Delay Time Modulation Depth: 0% ~ 100%)**
- ③ **InMode (Input Mode: Mix, Stereo)**
- ④ **HPF (High Pass Filter Frequency: THRU, 32Hz ~ 1.0kHz)**
- ⑤ **LPF (Low Pass Filter Frequency: 1.0kHz ~ 16kHz, THRU)**

NOTE: For a detailed explanation of each parameter see "Flanger" effect on page 37.

PITCH CHANGE EFFECTS

These effects can be used to produce pitch changes in vocal and instrument inputs.

In addition to the regular chromatic harmony pitch change the Mono Pitch Change, Dual Pitch Change and Triple Pitch Change effects offer an intelligent pitch change function which allows changes in pitch in harmony with the music style according to a specified key and scale. The program offers 7 preset scales to choose from and allows you to define and store 2 additional user scales. Harmonies are created depending on the input note, for example one octave higher for C, one 3rd higher for D, etc.

Mono Pitch Change (MonoPit)

1in/1out

This program produces a center position pitch change. The pitch difference between the the input signal and the effect signal can be set within the range of ± 1 octave. A feedback loop (13) allows adding repeats with increasingly pitch-shifted notes. Using a MIDI keyboard connected to the MIDI IN terminal, it is also possible to vary pitch change amounts automatically by assigning a specific pitch change to each input note.

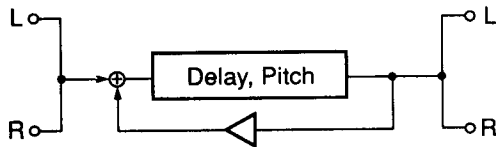

Parameters

① Intelli (Intelligent: ON, OFF)

This parameter is used to turn the intelligent pitch change function ON or OFF. When the function is ON, the Parameters ② to ③ and ① to ⑬ will be available to control the effect. When set to OFF, the chromatic pitch change parameters ⑩ to ⑭ are displayed.

• Intelligent pitch change parameters

② Key (Key: C ~ B) ★

Determines the base key for the intelligent pitch change scale.

③ Scale (Scale Type) ★

Allows selection of the scale to be used for the intelligent pitch change function. The unit offers 7 preset scales and 2 user scales which can be edited and stored in memory. (Only two user scales can be stored in total.)

NOTE: Please use the sound of the preset scales as a guideline when editing your own scales.

• Preset Scales

Major



Minor



Dorian



Whole Tone



Pentatonic



Lydian



Blues

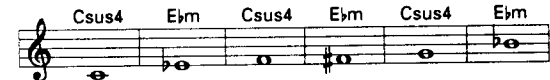

④ InNote (Input Note: Tonic ~ 7th) ★

⑤ Pitch (Pitch: -----, ↓ Oct ~ ↑ Oct) ★

These two parameters allow you to set pitch change amounts for individual notes when creating a user scale. After selecting each note (InNote) you can specify the desired pitch change for that note using the Pitch parameter.

The InNote tonic is the note set with the Key parameter. When the Pitch parameter is set to "-----", the pitch change applied to the corresponding note will be determined by the Pitch value of the previous note. For input sources with excessive vibrato, such as vocals, the Pitch parameter should be set to "-----" for notes that are not needed. (e.g. notes that are not part of the scale). This produces a more stable effect sound.

⑥ Save To (User-Scale: 1,2) ★

Allows storing a finished user scale in memory for later use. To store a scale, first select the desired memory location (1 or 2), and then press the ▲ function key under "Yes". To cancel the operation without storing the scale press the ▼ function key under "No".

NOTE: If you do not store the user scale data they will be lost when a different effect program is selected.

- ⑦ **Source (Control Source: Signal, MIDI) ★**
Selects between input signal and MIDI NOTE ON messages as the source controlling the effect.
- ⑧ **Sense (Control Sense: 0 ~ 5) ★**
Sets the sensitivity of the input pitch (frequency) detector. Please set to a value where stable pitch change is obtained.
- ⑨ **Tune (Tune: 438Hz ~ 445Hz) ★**
Allows setting a reference frequency for the input pitch detector. This parameter should be tuned to the standard pitch of the instrument. The value set here applies to all programs.

• Chromatic pitch change parameters

- ⑩ **Pitch (Pitch: ↓ Oct ~ ↑ Oct) ★**
Determines the musical interval (pitch difference) between the original sound and the pitch-shifted sound. This interval can be specified in semitone steps. “↓Oct” produces an effect sound which is one octave below the original sound and “↑Oct” a sound one octave above. When set to “Unison”, the effect pitch is the same as the pitch of the original sound. The musical interval set here also determines the amount of pitch change applied to the signal returned via the feedback loop. For instance, if you set the Pitch parameter to “↑½2nd” and apply feedback, inputting C3 will cause the following echo-like repeats, each shifted up by a semitone:



• Intelligent/chromatic pitch change parameters

- ⑪ **Fine (Pitch Fine: -100 ~ +100)**
Allows fine adjustment of the pitch difference between the original sound and the pitch-shifted sound defined by the Pitch parameter. Fine adjustment is possible in 1-cent steps (1/100 pitch). When set to “+100” (cent), for example, the input signal will be pitch-shifted by an additional semitone.
- ⑫ **Delay (Delay Time: 0.1msec ~ 1200.0msec)**
Determines the time delay between input of the original note and the output of the first pitch-shifted note. If the FbGain parameter is set to a value other than “0”, the Delay time also applies to the resulting feedback repeats.
- ⑬ **FbGain (Feed Back Gain: -99% ~ +99%)**
Determines the amount of pitch-shifted sound fed back to the input of the processor. Negative values result in inverse-phase feedback. The higher the absolute value, the higher the number of repeats. Absolute values close to “99” may cause oscillating sound.

• Chromatic pitch shift parameter

- ⑭ **Base Key (Base Key: OFF, C1 ~ C6) ★**
When the intelligent Pitch change function is ON, this parameter is not displayed. This parameter must be set if you want to control the pitch difference (interval) between the original sound and the pitch-shifted sound using NOTE ON messages from a connected MIDI keyboard. In this case, the pitch difference is determined by the interval between the Base Key set here and the note of the pressed key (MIDI NOTE ON message). If the Base Key is set to “C4”, for example, pressing C3 will produce a pitch change of one octave down, while pressing the D4 key will shift the pitch up by two semitones.

NOTE: The MIDI note number of C3 is “60”.

Example: The following illustration shows the pitch differences (intervals) between the Base Key and the other keys of the keyboard, when C4 is selected as the Base Key.

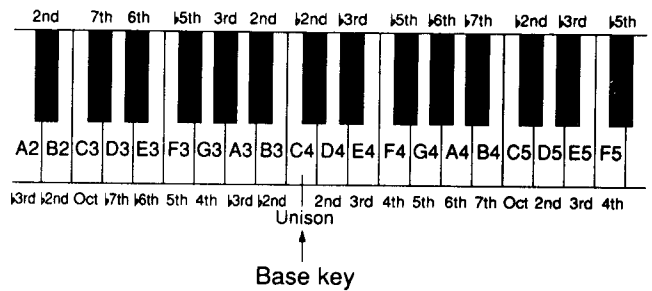

NOTE: The valid pitch shift range is ± 1 octave. Thus, if the change in pitch exceeds one octave, it will be corrected to a pitch within this range.

NOTE: If the Base Key parameter is set to OFF, pitch change cannot be controlled via MIDI NOTE ON messages.

NOTE: When controlling pitch change using MIDI NOTE ON messages, the last MIDI NOTE ON message received determines the current Pitch value.

Dual Pitch Change (DualPit)

1in/2out

The Dual Pitch Change program produces 2 pitch-shifted sounds for each input sound. The pitch difference between the original sound and the pitch-shifted sounds can be set within the range of ± 2 octaves. You can also set independent feedback loops for both pitch change processors.

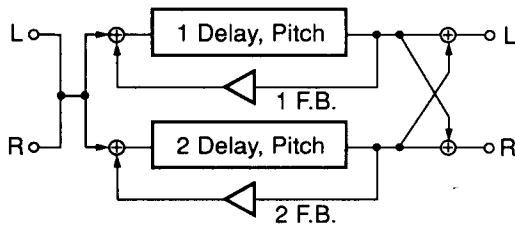

Parameters

① Intelli (Intelligent: ON, OFF)

This parameter is used to turn the intelligent pitch change function ON or OFF. When the function is ON, the Parameters ② to ⑩ and ⑬ to ⑳ will be available to control the effect. When set to OFF, the chromatic pitch change parameters ⑪ to ㉓ are displayed.

• Intelligent pitch change parameters

- ② Key (Key: C ~ B) ★
- ③ Scale (Scale Type) ★
- ④ InNote (Input Note: Tonic ~ 7th) ★
- ⑤ Pitch1 (Pitch 1: -----, ↓ ↓ Oct ~ ↑ ↑ Oct) ★
- ⑥ Pitch2 (Pitch 2: -----, ↓ ↓ Oct ~ ↑ ↑ Oct) ★
- ⑦ Save To (User-Scale: 1, 2) ★
- ⑧ Source (Control Source: Signal, MIDI) ★
- ⑨ Sense (Control Sense: 0 ~ 5) ★
- ⑩ Tune (Tune: 438Hz ~ 445Hz) ★

• Chromatic pitch change parameters

- ⑪ Pitch1 (Pitch 1: ↓ ↓ Oct ~ ↑ ↑ Oct) ★
- ⑫ Pitch2 (Pitch 2: ↓ ↓ Oct ~ ↑ ↑ Oct) ★

• Intelligent/chromatic pitch change parameters

- ⑬ Fine1 (Pitch Fine 1: -100 ~ +100)
- ⑭ Fine2 (Pitch Fine 2: -100 ~ +100)
- ⑮ Delay1 (Delay Time 1: 0.1msec ~ 650.0msec)
- ⑯ Delay2 (Delay Time 2: 0.1msec ~ 650.0msec)
- ⑰ Fb1Gain (Feed Back 1 Gain: -99% ~ +99%)
- ⑱ Fb2Gain (Feed Back 2 Gain: -99% ~ +99%)
- ⑲ Level1 (Level 1: 0% ~ 100%)
- ⑳ Level2 (Level 2: 0% ~ 100%)
Set the level of the effect signals.
- ㉑ Pan1 (Pan 1: 100/0 ~ 0/100)
- ㉒ Pan2 (Pan 2: 100/0 ~ 0/100)

Allow individual positioning of the Pitch1 and Pitch2 effects in the stereo sound field. A setting of 100/0 positions the effect sound fully to the left, 0/100 fully to the right and 50/50 in the center.

• Chromatic pitch change parameters

- ㉓ Base Key (Base Key: OFF, C1 ~ C6) ★
Sets the Base Key for pitch change control using MIDI NOTE ON messages.

NOTE: For detailed explanations of the effect parameters refer to "MonoPit" effect on page 39.

Triple Pitch Change (TripPit)

1in/2out

The Triple Pitch Change program produces 3 pitch-shifted sounds for each input sound. The pitch difference between the original sound and the pitch-shifted sounds can be set within the range of ± 2 octaves. Feedback is not possible.

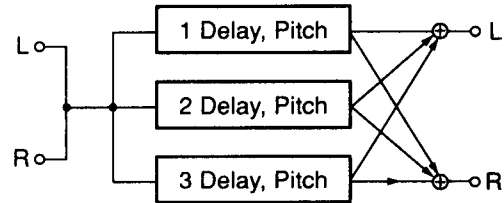

Parameters

① Intelli (Intelligent: ON, OFF)

This parameter is used to turn the intelligent pitch change function ON or OFF. When the function is ON, the Parameters ② to ⑩ and ⑬ to ㉓ will be available to control the effect. When set to OFF, the chromatic pitch change parameters ⑪ to ㉓ are displayed.

• Intelligent pitch change parameters

- ② Key (Key: C ~ B) ★
- ③ Scale (Scale Type) ★
- ④ InNote (Input Note: Tonic ~ 7th) ★
- ⑤ Pitch1 (Pitch 1: ↓ ↓ Oct ~ ↑ ↑ Oct) ★
- ⑥ Pitch2 (Pitch 2: ↓ ↓ Oct ~ ↑ ↑ Oct) ★
- ⑦ Pitch3 (Pitch 3: ↓ ↓ Oct ~ ↑ ↑ Oct) ★
- ⑧ Save To (User-Scale: 1, 2) ★
- ⑨ Source (Control Source: Signal, MIDI) ★
- ⑩ Sense (Control Sense: 0 ~ 5) ★
- ⑪ Tune (Tune: 438Hz ~ 445Hz) ★

• Chromatic pitch change parameters

- ⑫ Pitch1 (Pitch 1: -----, ↓ ↓ Oct ~ ↑ ↑ Oct) ★
- ⑬ Pitch2 (Pitch 2: -----, ↓ ↓ Oct ~ ↑ ↑ Oct) ★
- ⑭ Pitch3 (Pitch 3: -----, ↓ ↓ Oct ~ ↑ ↑ Oct) ★

• Intelligent/chromatic pitch change parameters

- ⑮ Fine1 (Pitch Fine 1: -100 ~ +100)
- ⑯ Fine2 (Pitch Fine 2: -100 ~ +100)
- ⑰ Fine3 (Pitch Fine 3: -100 ~ +100)
- ⑱ Delay1 (Delay Time 1: 0.1msec ~ 1400msec)
- ⑲ Delay2 (Delay Time 2: 0.1msec ~ 1400msec)
- ㉑ Delay3 (Delay Time 3: 0.1msec ~ 1400msec)
- ㉑ Level1 (Level 1: 0% ~ 100%)
- ㉒ Level2 (Level 2: 0% ~ 100%)
- ㉓ Level3 (Level 3: 0% ~ 100%)
- ㉔ Pan1 (Pan 1: 100/0 ~ 0/100)
- ㉕ Pan2 (Pan 2: 100/0 ~ 0/100)
- ㉖ Pan3 (Pan 3: 100/0 ~ 0/100)
Position the Pitch1, Pitch2 and Pitch3 effects in the same way as described for the "DualPit" program.

• Chromatic pitch change parameters

- ㉗ Base Key (Base Key: OFF, C1 ~ C6) ★

NOTE: For detailed explanations of the effect parameters refer to "MonoPit" effect on page 39 and "DualPit" effect.

Stereo Pitch Change (StPitch) 2in/2out

This program allows completely independent processing of two input signals. The pitch difference between the original sound and the pitch-shifted sounds can be set within the range of ± 2 octaves. You can also set independent feedback loops for both pitch change processors. The parameter settings apply to both channels (signals).

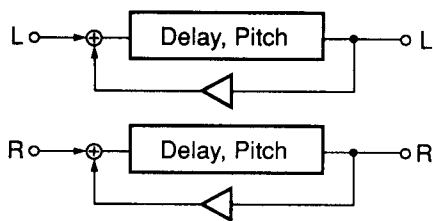

Parameters

- ① Pitch (Pitch: $\downarrow\downarrow$ Oct \sim $\uparrow\uparrow$ Oct) ★
Determines the musical interval (pitch difference) between the original sound and the pitch-shifted sound. This interval can be specified in semitone steps. " $\downarrow\downarrow$ Oct" produces an effect sound which is two octave below the original sound and " $\uparrow\uparrow$ Oct" a sound two octave above. When set to "Unison", the effect pitch is the same as the pitch of the original sound. The musical interval set here also determines the amount of pitch change applied to the signal returned via the feedback loop.
- ② Fine (Pitch Fine: -100 \sim +100)
Allows fine adjustment of the pitch difference between the original sound and the pitch-shifted sound defined by the Pitch parameter.
- ③ Delay (Delay Time: 0.1msec \sim 650.0msec)
Determines the time delay between input of the original sound and the output of the first pitch-shifted sound. If the FbGain parameter is set to a value other than "0", the Delay time also applies to the resulting feedback repeats.
- ④ FbGain (Feed Back Gain: -99% \sim +99%)
Determines the amount of pitch change to be fed back into the input of the processor.
Negative values result in inverse-phase feedback. The higher the absolute value, the higher the number of repeats. Absolute values close to "99" may cause oscillating sound.
- ⑤ Base Key (Base Key: OFF, C1 \sim C6) ★
Refer to "MonoPit" effect.

NOTE: When controlling pitch change using MIDI NOTE ON messages, the last MIDI NOTE ON message received determines the current Pitch value.

NOTE: The StPitch effect changes the pitch gradually without sudden variations.

PAN EFFECTS

Auto Pan (AutoPan) 1in/2out

This is a very sophisticated pan program that allows creation of "rotary" pan in addition to straightforward pan effects.

Parameters

- ① Type (Pan Type: L \rightarrow R, L \leftarrow R, L \leftrightarrow R, L-TURN, R-TURN)
Determines the direction in which the sound sweeps across the stereo sound field. The L-TURN and R-TURN parameters produce a pan which seems to rotate toward and away from the listener in the specified direction.
- L \rightarrow R

L \leftarrow R

L \leftrightarrow R
- L-TURN

R-TURN
- ② Speed (Speed: 0.05Hz \sim 40.0Hz)
Sets the speed of the PAN effect (i.e. how rapidly the signal sweeps from channel to channel).
 - ③ F/R Dep (Front/Rear Depth: 0% \sim 100%)
When the L-TURN or R-TURN pan type is selected, this parameter sets the apparent depth of the sweep from front to rear.
 - ④ L/R Dep (Lch/Rch Depth: 0% \sim 100%)
Sets the "depth" of the pan sweep from left to right and right to left.
 - ⑤ HPF (High Pass Filter Frequency: THRU, 32Hz \sim 1.0kHz)
Permits rolling off the high frequency content of the signal above the set frequency. The HPF is OFF when set to THRU.
 - ⑥ LPF (Low Pass Filter Frequency: 1.0kHz \sim 16kHz, THRU)
Permits rolling off the low frequency content of the signal below the set frequency. The LPF is OFF when set to THRU.

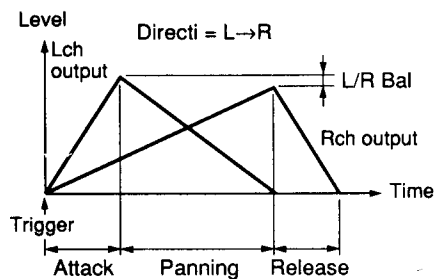
Triggered Pan (TrigPan)**1in/2out**

When triggered, this program automatically pans the sound image between left and right and left in the stereo sound field – with programmable attack, pan and release rates.

The following two trigger sources can be used:

- MIDI NOTE ON message
- Foot switch connected to the TRIGGER terminal

Parameters

- ① TrgLvl (Trigger Level: 1 ~ 100)
Determines the level of the input signal required to trigger the panning effect. At 100% only very high level input signals will trigger the pan, while at 0% even the tiniest input signal will trigger the pan.
- ② TrgDly (Trigger Delay Time: -100msec ~ +100msec)
Determines the delay between the time at which the effect is triggered and that at which it actually begins. If a minus value is programmed, the input signal is delayed so that, effectively, the effect begins before the signal appears.
- ③ TrgMsk (Trigger Mask: 3msec ~ 24000msec)
This parameter makes it impossible to re-trigger the effect until the programmed time has elapsed.
- ④ Attack (Attack Time: 3msec ~ 24000msec)
Determines how rapidly the panning effect begins.
- ⑤ Panning (Panning Time: 3msec ~ 24000msec)
Determines how long it takes to complete the main portion of the pan.
- ⑥ Release (Release Time: 3msec ~ 24000msec)
Determines the release time of the end of the pan.
- ⑦ Directi (Direction: L → R, L ← R)
Determines the direction in which the sound sweeps across the stereo sound field.
- ⑧ L/R Bal (Lch/Rch Balance: 0% ~ 100%)
Determines the maximum extent of the pan sweep. For example, a setting of 100% produces a full pan from the extreme left and vice versa.
- ⑨ MidiTrg (MIDI Trigger: OFF, ON) ★
When this parameter is turned ON, a MIDI NOTE ON message from an external MIDI keyboard can be used to trigger the pan.
- ⑩ HPF (High Pass Filter Frequency: THRU, 32Hz ~ 1.0kHz)
Permits rolling off the low frequency content of the signal below the set frequency. The HPF is OFF when set to THRU.
- ⑪ LPF (Low Pass Filter Frequency: 1.0kHz ~ 16kHz, THRU)
Permits rolling off the high frequency content of the signal above the set frequency. The LPF is OFF when set to THRU.

COMPLEX EFFECTS

The effect programs explained in this section combine several effects and thus can be used to create multi-effect signals. For a detailed explanation of each individual effect in the multi-effect programs please refer to the descriptions of the corresponding effect program with the same name.

Chorus & Reverb (Cho&Rev)

1in/2out

This is a multi-effect program consisting of Stereo Chorus and Stereo Reverb.

Parameters

- ① Direction (Effect Direction: Chorus+Reverb, Chorus → Reverb, Reverb → Chorus)

• Chorus+Reverb

The Chorus and Reverb signals are output in stereo and mixed at the L and R output stages.

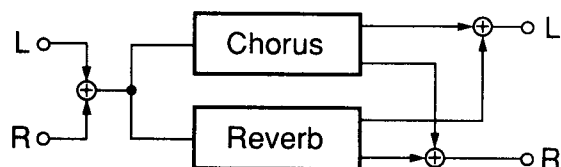

• Chorus → Reverb

The input signal first passes through the Chorus processor and then through the Reverb processor.

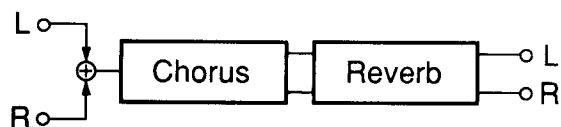

• Reverb → Chorus

The input signal first passes through the Reverb processor and then through the Chorus processor.

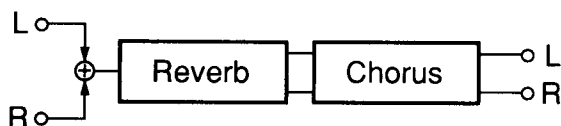

- ② ModFrq (Modulation Frequency: 0.05Hz ~ 40.0Hz)
- ③ DM.Dep (Delay Time Modulation Depth: 0% ~ 100%)
- ④ AM.Dep (Amplitude Modulation Depth: 0% ~ 100%)
Refer to "FM Cho" effect on page 38.
- ⑤ RevTime (Reverb Time: 0.3sec ~ 480.0sec)
- ⑥ HiRatio (High Ratio: RevTime x0.1 ~ x1.0)
- ⑦ IniDly (Initial Delay Time: 0.1msec ~ 800.0msec)
Refer to "Reverb" effect on page 25.
- ⑧ RevMix (Reverb Mixing Balance: 0% ~ 100%)
Determines the mix between the signal entering the reverb processor and the reverb sound. A bigger value causes more reverb sound.
- ⑨ TrgLvl (Trigger Level: 0% ~ 100%)
- ⑩ Release (Release Time: 3msec ~ 24000msec)
- ⑪ MidiTrg (MIDI Trigger: ON, OFF) ★
Refer to "Reverb" effect on page 25.

Symphonic & Reverb (Sym&Rev)

1in/2out

This is a multi-effect program combining the Stereo Symphonic and Stereo Reverb.

Parameters

- ① Direction (Effect Direction: Sympho+Reverb, Sympho → Reverb, Reverb → Sympho)
Refer to "Cho&Rev" effect.
- ② ModFrq (Modulation Frequency: 0.05Hz ~ 40.0Hz)
- ③ Depth (Modulation Depth: 0% ~ 100%)
Refer to "Symphon" effect on page 38.
- ④ RevTime (Reverb Time: 0.3sec ~ 480.0sec)
- ⑤ HiRatio (High Ratio: RevTime x0.1 ~ x1.0)
- ⑥ IniDly (Initial Delay Time: 0.1msec ~ 800.0msec)
Refer to "Reverb" effect on page 25.
- ⑦ RevMix (Reverb Mixing Balance: 0% ~ 100%)
Determines the balance between the direct and effect sound. Higher values produce a greater proportion of the effect sound in relation to the direct sound.
- ⑧ TrgLvl (Trigger Level: 0% ~ 100%)
- ⑨ Release (Release Time: 3msec ~ 24000msec)
- ⑩ MidiTrg (MIDI Trigger: ON, OFF) ★
Refer to "Reverb" effect on page 25.

Flanger & Reverb (Fig&Rev)**1in/2out**

This is a multi-effect program combining Stereo Flanger and Stereo Reverb.

Parameters

- ① **Direction** (Effect Direction: Flange+Reverb, Flange → Reverb, Reverb → Flange)
Refer to “Cho&Rev” effect on page 44.
- ② **ModFrq** (Modulation Frequency: 0.05Hz ~ 40.0Hz)
- ③ **Depth** (Modulation Depth: 0% ~ 100%)
- ④ **Delay** (Delay Time: 0.1msec ~ 20.0msec)
- ⑤ **FbGain** (Feed Back Gain: 0% ~ 99%)
Refer to “Flanger” effect on page 37.
- ⑥ **RevTime** (Reverb Time: 0.3sec ~ 480.0sec)
- ⑦ **HiRatio** (High Ratio: RevTime x0.21 ~ x1.0)
- ⑧ **IniDly** (Initial Delay Time: 0.1msec ~ 800.0msec)
Refer to “Reverb” effect on page 25.
- ⑨ **RevMix** (Reverb Mixing Balance: 0% ~ 100%)
Determines the mix balance between the signal entering the reverb processor and the reverb sound.
- ⑩ **TrgLvl** (Trigger Level: 0% ~ 100%)
- ⑪ **Release** (Release Time: 3msec ~ 24000msec)
- ⑫ **MidiTrg** (MIDI Trigger: ON, OFF) ★
Refer to “Reverb” effect on page 25.

Reverb(L)/ Reverb(R) (Rev/Rev)**2in/2out**

This is a dual effect program in which the input signal of the left channel is processed by the Plate Rev. effect and the signal of the right channel by the Hall Rev. effect.

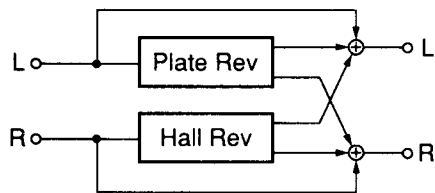
**Parameters**

NOTE: Balan1 controls the mix level of Plate Rev.
Balan2 controls the mix level of Hall Rev.

- ① **PltRvT** (Plate Reverb Time: 0.3sec ~ 480.0sec)
Sets the left channel reverb time.
- ② **PltHiR** (Plate Reverb High Ratio: PltRvt x0.1 ~ x1.0)
Allows alteration of the high frequency plate reverb time in relation to the overall reverb time.

- ③ **PltDif** (Plate Reverb Diffusion: 0 ~ 10)
Sets the complexity of the many reflections that make up reverberation.
- ④ **PltDly** (Plate Reverb Delay Time: 0.1msec ~ 200msec)
Determines the time until the first plate reverb sound occurs.
- ⑤ **HalRvT** (Hall Reverb Time: 0.3sec ~ 480.0sec)
Sets the right channel reverb time.
- ⑥ **HalHiR** (Hall Reverb High Ratio: HalRvt x0.1 ~ x1.0)
Allows alteration of the high frequency hall reverb time in relation to the overall reverb time.
- ⑦ **HalDif** (Hall Reverb Diffusion: 0 ~ 10)
Sets the complexity of the many reflections that make up reverberation.
- ⑧ **HalDly** (Hall Reverb Delay Time: 0.1msec ~ 200msec)
Determines the time until the first hall reverb sound occurs.
- ⑨ **Output** (Output Mode: Stereo, Monox2)
When set to Stereo, the output signals of the left and right channel processors are mixed and then output in stereo. When monox2 is selected, the left and right channel signals are output independently.

• Stereo

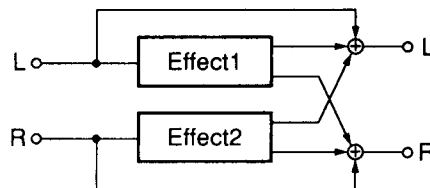

• Monox2

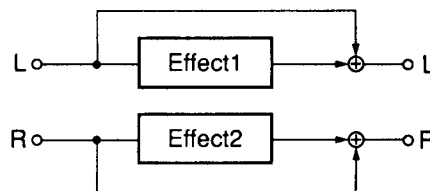

- ⑩ **PltLPF** (Plate Reverb Low Pass Filter Frequency: 1.0kHz ~ 16kHz, THRU)
Permits rolling off the high frequency content of the Plate signal above the set frequency. The LPF is OFF when set to THRU.
- ⑪ **HallLPF** (Hall Reverb Low Pass Filter Frequency: 1.0kHz ~ 16kHz, THRU)
Permits rolling off the high frequency content of the Hall signal above the set frequency. The LPF is OFF when set to THRU.

ER (L)/Reverb (R) (ER/Rev)**2In/2out**

This is a dual effect program in which the input signal of the left channel is processed by the ER effect and the signal of the right channel by the Reverb effect.

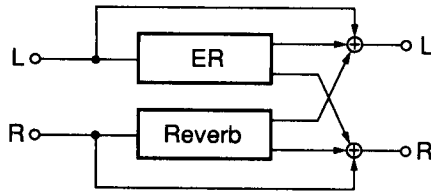
**Parameters**

NOTE: Balan1 controls the mix level of ER.

Balan2 controls the mix level of Reverb.

- ① ErType (Early Reflection Type: S-Hall, L-Hall, Random, Reverse, Plate, Spring)
Selects the early reflection pattern.
- ② Room (ER Room Size: 0.1 ~ 25.0)
Simulates the room size.
- ③ Live (ER Liveness: 0 ~ 10)
Determines how the early reflections decay.
- ④ Diffuse (ER Diffusion: 0 ~ 10)
Sets the complexity of the many reflections that make up the reverberation.
- ⑤ ErDly (E Initial Delay Time: 0.1msec ~ 300.0msec)
Sets the time delay between the direct sound and the first of the many reflections that make up reverberation.

The above ER parameters control the left channel input signal. The following parameters ⑥ ~ ⑨ affect the right channel input signal.

- ⑥ RevTime (Reverb Time: 0.3sec ~ 480.0sec)
Sets the time of the reverb sound.
- ⑦ HiRatio (REVERB High Ratio: RevTime x0.1 ~ x1.0)
Allows alteration of the high frequency reverb time in relation to the overall reverb time.
- ⑧ Diffuse (REVERB Diffusion: 0 ~ 10)
Sets the complexity of the many reflections that make up the reverberation.
- ⑨ RevDly (REVERB Initial Delay Time: 0.1msec ~ 300.0msec)
Sets the time delay between the direct sound and the first of the many reflections that make up the reverberation.

- ⑩ Output (Output Mode: Stereo, Monox2)

When set to Stereo, the output signals of the left and right-channel processors are mixed and then output in stereo. When Monox2 is selected, the left and right-channel signals are output independently.

Refer to "Rev/Rev" effect on page 45.

- ⑪ RevLPF (REVERB Low Pass Filter Frequency: 1kHz ~ 16kHz, THRU)
Permits rolling off the high-frequency content of the Rev signal above the set frequency. The LPF is OFF when set to THRU.

Echo (L)/ Reverb (R) (Ech/Rev)**2In/2out**

This is a dual effect program in which the input signal of the left channel is processed by the Echo effect and the signal of the right channel by the Reverb effect.

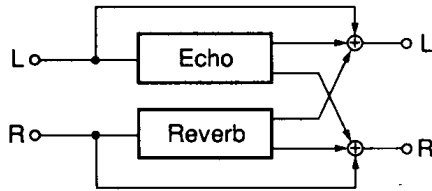
**Parameters**

NOTE: Balan1 controls the mix level of Echo.
Balan2 controls the mix level of Reverb.

- ① L.FbDly (ECHO Lch Delay Time: 0.1msec ~ 350.0msec)
Determines the time interval for the left channel echo repeats produced after the initial delay.

Direct Sound (Lch)

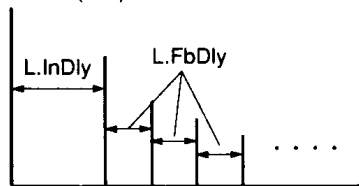

- ② L. Fb (ECHO Lch Feed Back Gain: -99% ~ +99%)
Sets the amount of left channel delay signal fed back to the input of the processor.
- ③ R.FbDly (ECHO Rch Feed Back Gain: 0.1msec ~ 350.0msec)
- ④ R.Fb (ECHO Rch Feed back Gain: -99% ~ +99%)
These parameters for the right channel have the same functions as ① and ②.
- ⑤ High (ECHO High Frequency Feed Back Gain: x0.1 ~ x1.0)
Controls feedback in the high frequency range on both the left and right channels.
- ⑥ RevTime (Reverb Time: 0.3sec ~ 480.0sec)
Sets the time of the reverb sound.
- ⑦ HiRatio (REVERB High Ratio: RevTime x0.1 ~ x1.0)
Allows alteration of the high frequency reverb time in relation to the overall reverb time.
- ⑧ Diffuse (REVERB Diffusion: 0 ~ 10)
Sets the complexity of the many reflections that make up the reverberation.

- ⑨ RevDly (REVERB Initial Delay Time: 0.1msec ~ 200msec)

Sets the time until the reverb sound occurs.

- ⑩ Output (Output Mode: Stereo, Monox2)

When set to Stereo, the output signals of the left and right-channel processors are mixed and then output in stereo. When Monox2 is selected, the left and right-channel signals are output independently.

Refer to "Rev/Rev" effect on page 45.

- ⑪ L.InDly (ECHO Lch Initial Delay Time: 0.1msec ~ 350.0msec)

The time delay between the input from the left channel and the initial echo output sound from the left channel.

- ⑫ R.IniDly (ECHO Rch Initial Delay Time: 0.1msec ~ 350.0msec)

The time delay between the input from the right channel and the first echo output sound from the right channel.

- ⑬ RevLPF (REVERB Low Pass Filter Frequency: 1kHz ~ 16kHz, THRU)

Sets the cutoff frequency of the low pass filter. The LPF is OFF when set to THRU.

Chorus(L)/ Reverb(R) (Cho/Rev)**2in/2out**

This is a dual effect program in which the input signal of the left channel is processed by the Chorus effect and the signal of the right channel by the Reverb effect.

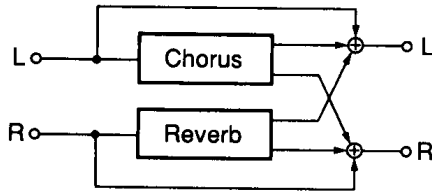
**Parameters**

NOTE: Balan1 controls the mix level of Chorus.

Balan2 controls the mix level of Reverb.

- ① **ModFrq** (CHORUS Modulation Frequency: 0.05Hz ~ 40.0Hz)
Sets the speed of modulation, and hence the rate at which the effect varies.
- ② **DM.Dep** (CHORUS Delay Time Modulation Depth: 0% - 100%)
Sets the modulation width between the L and R channels of the Chorus effect.
- ③ **AM.Dep** (CHORUS Amplitude Modulation Depth: 0% ~ 100%)
Sets the width of the Chorus volume variation.
- ④ **RevTime** (Reverb Time: 0.3sec ~ 480.0sec)
Sets the right channel reverb time.
- ⑤ **HiRatio** (REVERB High Ratio: RevTime x0.1 ~ x1.0)
Allows alteration of the high frequency reverb time in relation to the overall reverb time.
- ⑥ **Diffuse** (REVERB Diffusion: 0 ~ 10)
Sets the complexity of the many reflections that make up reverberation.
- ⑦ **RevDly** (REVERB Initial Delay Time: 0.1msec ~ 300.0msec)
Sets the delay time until the initial reverb sound occurs.
- ⑧ **Output** (Output Mode: Stereo, Monox2)
When set to Stereo, the output signals of the left and right channel processors are mixed and then output in stereo. When Monox2 is selected, the left and right channel signals are output independently.
Refer to "Rev/Rev" effect on page 45.
- ⑨ **RevLPF** (REVERB Low Pass Filter Frequency: 1kHz ~ 16kHz, THRU)
Sets the cutoff frequency of the low pass filter. The LPF is OFF when set at THRU.

Pan(L)/Pan(R) (Pan/Pan)**2in/2out**

This is an effect program in which the input signals both the left and right channels are processed by two pan effects independently.

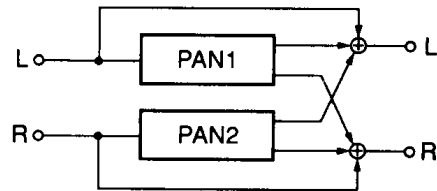
**Parameters**

NOTE: Balan1 controls the mix level of PAN1 (Lch).

Balan2 controls the mix level of PAN2 (Rch).

- ① **Type1** (1 Pan Type: L → R, L ← R, L ↔ R, L-TURN, R-TURN)
- ② **Speed1** (1 Panning Speed: 0.05Hz ~ 40.0Hz)
- ③ **F/R Dep1** (1 Front/Rear Depth: 0% ~ 100%)
- ④ **L/R Dept1** (1 Lch/Rch Depth: 0% ~ 100%)
- ⑤ **Delay1** (1 Initial Delay Time: 0.1msec ~ 700.0msec)
The above are parameters for PAN1.
- ⑥ **Type2** (2 Pan Type: L → R, L ← R, L ↔ R, L-TURN, R-TURN)
- ⑦ **Speed2** (2 Panning Speed: 0.05Hz ~ 40.00Hz)
- ⑧ **F/R Dep2** (2 Front/Rear Depth: 0% ~ 100%)
- ⑨ **L/R Dep2** (2 Lch/Rch Depth: 0% ~ 100%)
- ⑩ **Delay2** (2 Initial Delay Time: 0.1msec ~ 700.0msec)
The above are parameters for PAN2.

The functions of the Pan parameters are the same as described under PAN EFFECTS on page 42. Two signal inputs create two different Pan effects.

- ⑪ **Phase** (Phase: -180.0deg ~ +180.0deg)
Determines the starting phase of the right-channel pan (PAN2) in relation to the left-channel pan (PAN1).
Sets the angle of rotation between PAN1 and PAN2 positions. If PAN1 and PAN2 both are set to the same Type and Speed, the angle between PAN1 and PAN2 is 90°, the sound will move without changing the angle.

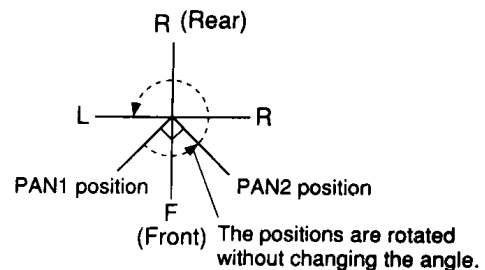

FREEZE EFFECT

The Freeze effect is a sampling function. It can be used to “record” (store) a sound (input signal) in the internal memory. This sound then can be played back repeatedly as required.

Freeze (Freeze)

1In/2out

Allows sampling of a monaural sound source and playback of the sample using a loop. The maximum sampling time is 1.35 seconds and a sampling frequency of 44.1 kHz and 20-bit quantization allow high-quality sound recording. For playback you can specify a start and end point within the sample to cut unneeded portions of the recorded sound. Furthermore, you can change the pitch of the playback sound.

NOTE: The recorded sound sample will be erased when the power is turned off.

NOTE: The recorded sound will also be erased when you select a different program.

NOTE: When the Stereo input mode is selected, the left channel input signal will be recorded.

RECORDING/OVERDUBBING

To record a sample, first recall the Freeze effect and then select the recording screen (shown below) using the PAGE select keys (△ / ▽).

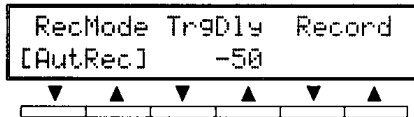

- **TrgDly (Trigger Delay Time: -1350msec ~ +1000msec)**
Determines the recording start point in reference to the trigger point.
If TrgDly is set to 0, the recording is triggered without delay. If a negative value is set, the recording start point will be moved ahead of the trigger point. A negative value is recommended if the head portion of the sound to be recorded is likely to get cut off, which usually happens with “AutRec” and “AutOvr”.

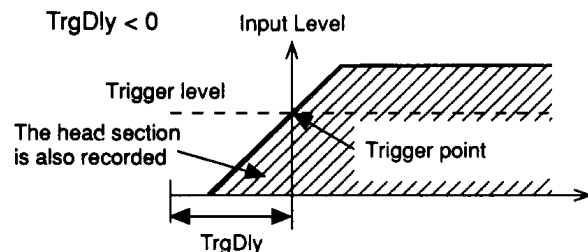
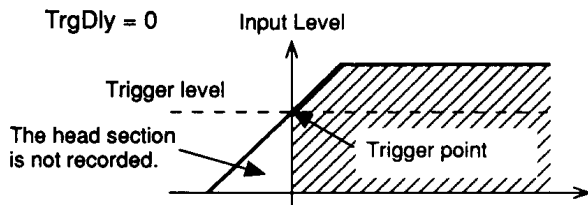

- **RecMode (Recording Mode) ★**
Selects the recording/overdubbing mode.
- **ManRec (Manual Recording)**
To manually trigger the recording using one of the following two trigger sources:
 1. Function key below “Record” on the LCD display
 2. Foot switch connected to TRIGGER terminal
 While the signal is recorded, “-----” is shown on the display under “Record”. When sampling is completed, “OK” will be displayed.
Executing the recording function will erase all previously recorded sound data.
- **ManOvr (Manual Overdubbing)**
Over Dubbing manually the triggering effect.
For overdubbing using a manual trigger. The trigger sources described under ManRec can be used.
Overdubbing will add new sound to the previously recorded sound.
- **AutRec (Auto Recording)**
To automatically trigger the recording using the input signal level as the trigger source.
NOTE: When a negative TrgDly value is set, the input signal will actually be recorded from before the trigger point. When a positive value is set, the recording will start after the specified delay.
While the signal is recorded, “-----” is shown on the display under “Record”. When sampling is completed, “OK” will be displayed.
Executing the recording function will erase all previously recorded sound data.
- **AutOvr (Auto Overdubbing)**
For overdubbing using the input signal level as the trigger source.
Overdubbing will add new sound to the previously recorded sound.

PLAYBACK

To play back the recorded sample, change to one of the playback screens (following pages) using the PAGE select keys (△ / ▽). Each of these screens allows you to start and stop playback using one of the following methods:

1. ▽ or ▲ function key under “PlayStop”.
2. Footswitch connected to TRIGGER terminal.
3. MIDI NOTE ON (Start) and OFF (Stop) messages from an external MIDI keyboard.

Setting of Start and End Points for Playback

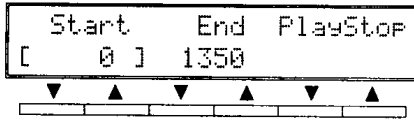

- Start (Start Point: 0msec ~ 1350msec)
- END (End Point: 0msec ~ 1350msec)

A recorded sample may contain a soundless or otherwise unneeded portion at the beginning or end. These two parameters allow you to specify the playback Start and End points to tailor the sample length to your needs. If the End point time is shorter than the Start point time (e.g. End point before Start point), the sampled sound will be played back in reverse.

Example:Recording of the words "ONE TWO THREE FOUR FIVE"

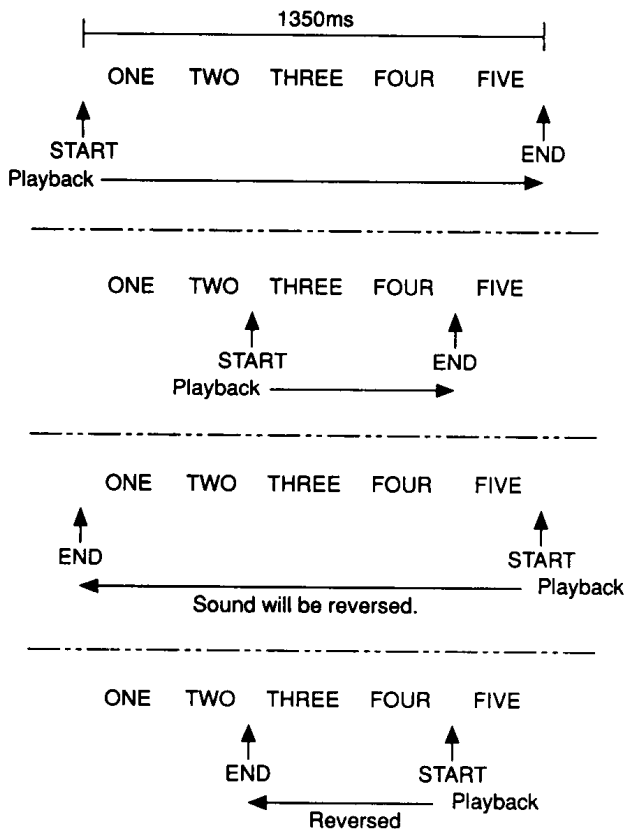

Playback Loop

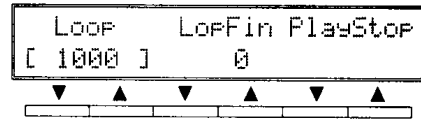

- Loop (Loop Point: 0msec ~ 1350msec)
- LopFin (Loop Fine: -200 ~ +200)

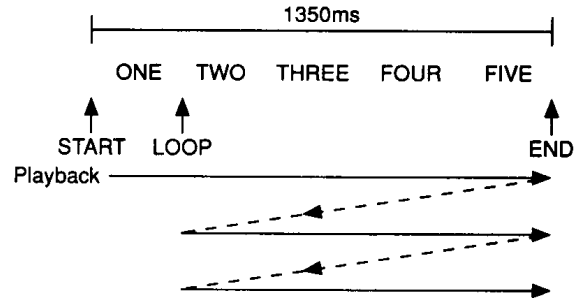

"Loop" sets the starting point for the playback repeats following the initial playback of the sample. The set playback loop (Loop point to End point) will be repeated until the next trigger signal (Stop) is received. However, if the Loop point is set to a time within 5 msec before the End point, the sample will be played only once.

The "LoopFin" parameter allows shifting the set Loop point in steps of one sampling unit each for fine adjustment. Also, if the End point is set earlier than the Start point, the sample will be looped in reverse. If the Loop point is set to within 5 msec after the End point, the sample will be played only once.

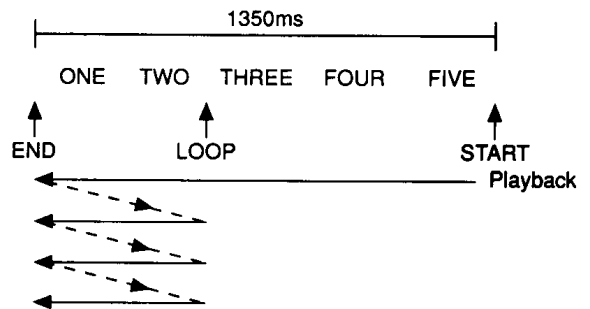

Changing of Pitch During Playback

Pitch Change Control Using the SPX990



- Pitch (Pitch: ↓ ↓ Oct ~ ↑ ↑ Oct) ★
- Fine (Pitch Fine: -100 ~ +100)
Allows changing the pitch of the playback sound similar to the Pitch effect programs within a range of ± 2 octaves. The "Fine" parameter controls the set pitch in one-cent increments (one cent equals 1/1000th of a semitone) within a range of ± 100 .

MIDI-controlled Pitch Change

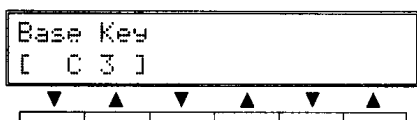

- Base Key (Base Key: OFF, C1 ~ C6) ★
Allows changing the Pitch value using MIDI NOTE ON messages. (Refer to "MonoPit" effect.)
Playback stops when a MIDI NOTE OFF message is received (when you release a key on the keyboard).

MIDI CONTROL

The SPX990 is equipped with MIDI terminals that allow connection to an external MIDI device for MIDI-controlled program selection, parameter setting and other operations. MIDI stands for "Musical Instrument Digital Interface", the data communication standard for electronic instruments and audio equipment. To use MIDI control you must connect the unit to the MIDI terminal of another MIDI device (keyboard, etc.) and set the MIDI parameters accordingly. Also refer to the owner's manual of the other MIDI device.

MIDI TERMINALS

SPX 990 MIDI Terminals

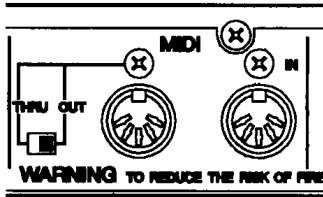

MIDI IN

This terminal enables the SPX990 to receive MIDI information. To receive data it must be connected to the MIDI OUT terminal of another MIDI device.

MIDI OUT/THRU

This terminal functions either as a MIDI OUT jack or as a MIDI THRU jack, depending on the setting of the MIDI OUT/THRU switch. Connect this terminal to the MIDI IN terminal of another MIDI device.

MIDI OUT

When the MIDI OUT/THRU switch is set to OUT, you can bulk dump effect program data or program change table data of the SPX990 to an external MIDI device.

MIDI THRU

When the MIDI OUT/THRU switch is set to THRU, the terminal outputs the information received from other MIDI devices via the MIDI IN terminal.

MIDI OPERATIONS

The following operations are possible using MIDI control:

■ Program Change

The effect programs of the SPX990 can be changed (recalled) by sending program change messages from another MIDI device. When you select a voice on a connected MIDI keyboard, a corresponding program change number is automatically transmitted which will recall a program on the SPX990.

MIDI keyboard, sequencer
MIDI foot controller, etc.

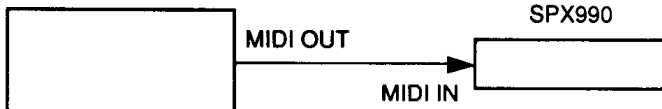

Using the MIDI OUT/THRU terminal of the SPX990 you can re-transmit these messages to control other MIDI devices (if you use several SPX990 in a chain, for example).

Preparations:

- Match the MIDI transmit channel of the external MIDI device to the MIDI receive channel of the SPX990 bank to be used. (Refer to MIDI PROGRAM CHANGE TABLE SETUP on page 55.)
- Assign the memory numbers (U01 – U99, U00, C01 – C99, C00, ---, P01 – P80) to be used to individual program change numbers (PGM1 – 128). (Refer to MIDI PROGRAM CHANGE TABLE SETUP on page 55.)
- Select the desired bank. (Refer to MIDI PROGRAM CHANGE TABLE SETUP on page 55.)
- If you want to re-transmit the program change messages received via MIDI IN to another unit, connect it to the MIDI OUT/THRU terminal of the SPX990 and set the MIDI OUT/THRU switch to THRU.

■ Parameter Control

You can change parameter settings of the currently selected SPX990 program by sending control change messages from a connected MIDI device.

In this way you can input parameter values using the data entry keys of an external MIDI device, for example.

MIDI keyboard, sequencer
MIDI foot controller, etc.

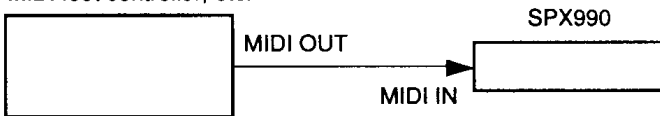

Preparations:

- Choose one of the following controllers (refer to “1. Controller Assignment” on page 56):
 - Any control change message
 - Note No. or velocity of NOTE ON message
 - Channel pressure
- Specify the parameters to be controlled for each program. (Refer to “2. Parameter Assignment” on page 57.)
- Match the MIDI transmit channel of the external MIDI device to the MIDI receive channel of the SPX990 bank to be used. (Refer to MIDI PROGRAM CHANGE TABLE SETUP on page 55.)
- Recall the program to be controlled.

■ MIDI Trigger

For programs whose main effect is Reverb, FiltRev, EchRoom or TrigPan you can use a NOTE ON message transmitted by an external MIDI device as a trigger source to control opening of the gate.

In this way you can apply the effect as soon as sound is produced by playing a key.

MIDI keyboard, sequencer
MIDI foot controller, etc.

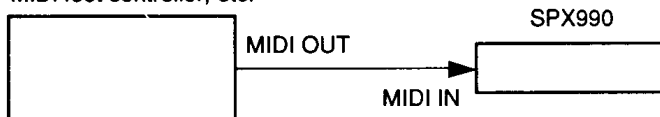

Preparations:

- Match the MIDI transmit channel of the external MIDI device to the MIDI receive channel of the SPX990 bank to be used. (Refer to MIDI PROGRAM CHANGE TABLE SETUP on page 55.)
- Recall the program and set its MidiTrg parameter to ON.

■ Pitch Control

You can use NOTE ON messages transmitted by an external MIDI device to control the pitch change interval/playback pitch for programs with the following main effects in real-time:

- MonoPit (Intelli OFF)
- DualPit (Intelli OFF)
- TripPit (Intelli OFF)
- StPit
- Freeze

In this way you can change the pitch change interval/playback pitch using the keys of a connected MIDI keyboard.

MIDI keyboard, sequencer
MIDI foot controller, etc.

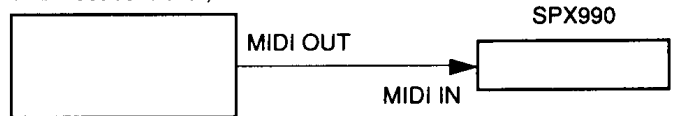

Preparations:

- Match the MIDI transmit channel of the external MIDI device to the MIDI receive channel of the SPX990 bank to be used. (Refer to MIDI PROGRAM CHANGE TABLE SETUP on page 55.)
- Recall the program, set its Intelli parameter to OFF and select the base key using the BaseKey parameter.

■ Pitch Control (Intelli ON)

NOTE ON messages transmitted by an external MIDI device can also be used to control the pitch change interval instead of using the scale intervals set for each input note by the intelligent pitch change function. This pitch control is possible for programs with the following main effects:

- MonoPit
- DualPit
- TripPit

When you press a key on a connected MIDI keyboard, for example, the pitch change interval set for this note will be applied instead of the interval set for the note of the input signal.

MIDI keyboard, sequencer
MIDI foot controller, etc.

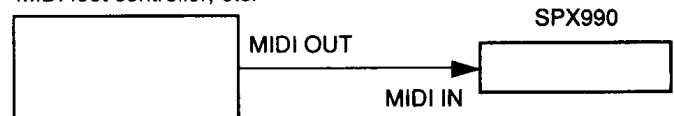

Preparations:

- Match the MIDI transmit channel of the external MIDI device to the MIDI receive channel of the SPX990 bank to be used. (Refer to MIDI PROGRAM CHANGE TABLE SETUP on page 55.)
- Recall the program, set its Intelli parameter to ON and set the Trig parameter to MIDI.

■ Tempo Control

You can use the MIDI clock of an external MIDI device to control the Tempo parameter for programs with the following main effects:

- TmpEch1
- TmpEch2
- TmpEch4

When using a sequencer, for example, the delay time will be controlled to match the tempo of the music played back.

MIDI keyboard, sequencer
MIDI foot controller, etc.

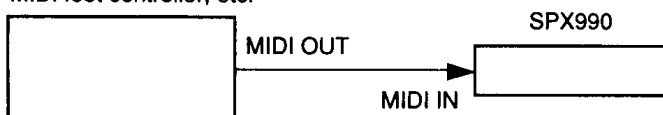

Preparations:

- Set the MIDI receive channel of the SPX990 bank to be used to any other value than OFF. (Refer to MIDI PROGRAM CHANGE TABLE SETUP on page 55.)
- Recall the program and set the Trig parameter to MIDI.

■ Bulk Dump to an External Device

You can bulk dump the data in the SPX990 to another SPX990, a MIDI data filer or a computer for permanent storage.

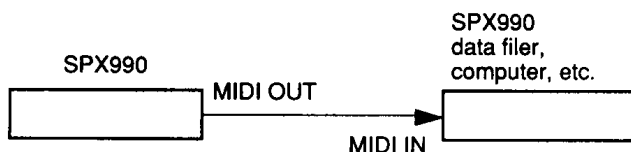

Preparations:

- Match the MIDI transmit channel of the currently selected bank to the MIDI receive channel of the other SPX990, etc. (Refer to MIDI PROGRAM CHANGE TABLE SETUP on page 55.)
- Specify the bulk data to be transmitted. (Refer to MIDI BULK OUT on page 58.)

■ Bulk Dump Request

You can also initiate transmission of the SPX990 bulk data by sending a bulk dump request from an external computer.

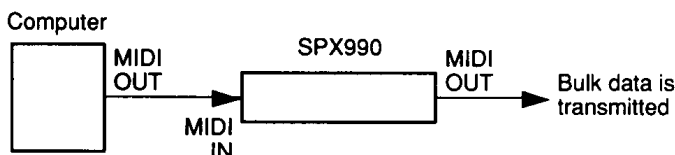

Preparations:

- Match the MIDI receive/transmit channel of the currently selected bank to the MIDI transmit channel of the computer and the MIDI receive channel of the external MIDI device used for storage. (Refer to MIDI PROGRAM CHANGE TABLE SETUP on page 55.)

■ Bank Change Request

It is also possible to switch banks by sending a bank change request message (system exclusive message) from a computer.

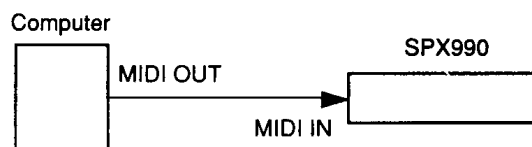

Preparations:

- Match the MIDI receive channel of the currently selected SPX990 bank to the MIDI transmit channel of the computer. (Refer to MIDI PROGRAM CHANGE TABLE SETUP on page 55.)

■ Bulk Dump from an External Device

The SPX990 can also receive (“load”) bulk data from another SPX990, a MIDI data filer or a computer, etc.

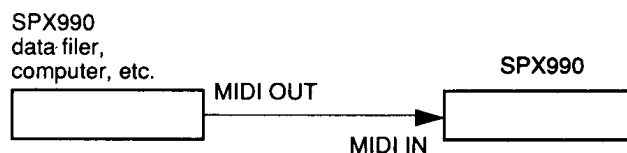

Preparations:

- Set User’s Memory Protect to “Off”. (Refer to USER’S MEMORY PROTECT FEATURE on page 17.)
- Match the MIDI receive channel of the currently selected SPX990 bank to the MIDI transmit channel of the other SPX990, etc. (Refer to MIDI PROGRAM CHANGE TABLE SETUP on page 55.)

NOTE: The received bulk data will replace all data stored in the corresponding memory locations.

■ MIDI Indicator

When the SPX990 receives MIDI data, the MIDI indicator on the front panel lights up.

MIDI PROGRAM CHANGE TABLE SETUP (Edit Mode: Page 3)

4 MIDI transmit/receive channel and program change tables can be set in banks A ~ D. The banks are arranged as shown below and allow setting of the channel number and program memory numbers at the positions marked by a question mark ("?").

Bank Name		MIDI receive channel number	
BANK : A ch = ?		BANK : B ch = ?	
MIDI-PGM	SPX-MEM	MIDI-PGM	SPX-MEM
1	= ?	1	= ?
2	= ?	2	= ?
3	= ?	3	= ?
⋮	⋮	⋮	⋮
128	= ?	128	= ?
BANK : C ch = ?		BANK : D ch = ?	
MIDI-PGM	SPX-MEM	MIDI-PGM	SPX-MEM
1	= ?	1	= ?
2	= ?	2	= ?
3	= ?	3	= ?
⋮	⋮	⋮	⋮
128	= ?	128	= ?

↑ Program change number (from keyboard, etc.)
 ↑ Memory number of SPX990

Setting Procedure:

- Press the EDIT key to enter the edit mode and select Page3 using the PAGE select keys (△ / ▽).

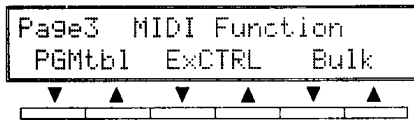

- Press the ▽ or ▲ function key under "PGMtbl" to display the bank select screen.

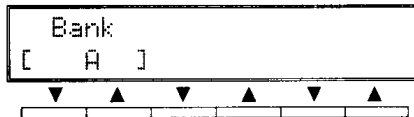

- Select the desired bank using the function keys under "Bank".

NOTE: If you only want to switch banks without changing any of the settings, continue with step ⑧.

- Press the △ PAGE select key to change to the menu screen shown below. Use the ▽ and ▲ function keys under "Channel" to specify the MIDI transmit/receive channel for the selected bank.

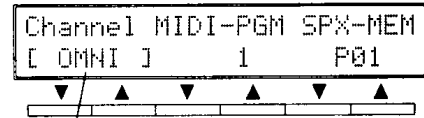

MIDI transmit/receive channel settings:

OMNI Reception on all channels, transmission on channel 1.

1 Reception/transmission on channel 1.

2 Reception/transmission on channel 2.

⋮

⋮

16 Reception/transmission on channel 16.

OFF Reception/transmission disabled.

- Press the ▽ or ▲ function key under "MIDI-PGM" to select the MIDI Program number (1 ~ 128).

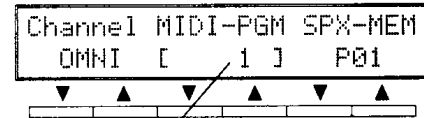

MIDI Program No.: 1 ~ 128

- Press the ▽ or ▲ function key under "SPX-MEM" to assign an SPX program number to the MIDI Program number.

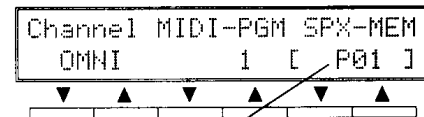

SPX990 Program No.:

P01~P80 Preset Memory numbers

U01~U99, U00 User Memory numbers

C01~C99, C00 Card Memory numbers

- Repeat steps ⑤ and ⑥ to assign other programs.
- Press the EDIT key to return to Page3 of the edit mode, or the MEMORY key to return to the memory mode.

MIDI PARAMETER CONTROL (Edit Mode: Page 2 and 3)

Parameter values of the currently selected SPX990 effect program can be changed by sending Control Change messages or NOTE ON messages from an external MIDI device. To use MIDI parameter control, prepare the unit as follows:

1. Controller Assignment (Edit Mode: Page 3)

This function allows you to assign control change numbers to two controllers (1 and 2) to control effect parameters using control change messages from an external MIDI device.

NOTE: The controller assignment applies to all programs.

Setting Procedure:

- ① Press the EDIT key to enter the edit mode and select Page3 using the PAGE select keys (△ / ▽).

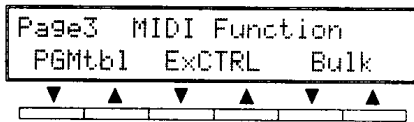

- ② Press the ▼ or ▲ function key under "ExCTRL" to display the controller assignment screen.

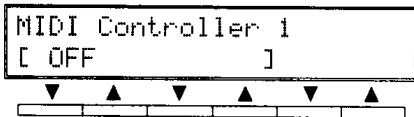

- ③ Press one of the PAGE select keys (△ / ▽) to select Controller 1 or 2.

- ④ Select the control change number to be assigned using the function keys under "[]".



Control change No.:

OFF	Control messages will be ignored.
1 MOD WH	Control change No. 1
2 BREATH	Control change No. 2
⋮	⋮
⋮	⋮
⋮	⋮
95	Control change No. 95

- ⑤ Repeat steps ③ and ④ to assign the other controller, if necessary.

NOTE: If the same control change number is assigned to controllers 1 and 2, you can control the parameters assigned in the next section simultaneously.

- ⑥ Press the EDIT key to return to Page3 of the edit mode, or the MEMORY key to return to the memory mode.

2. Parameter Assignment (Edit Mode: Page 2)

The parameters that will be controlled by controllers 1 and 2 can be assigned for each program individually. You can also specify the allowable control range.

Setting Procedure:

- Recall the desired program. (Refer to MEMORY RECALL on page 10.)

- Press the EDIT key to enter the edit mode and select Page2 using the PAGE select keys (Δ / ∇).

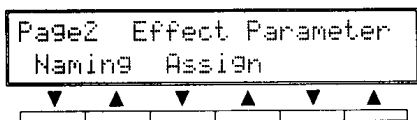

- Press the ∇ or \blacktriangle function key under "Assign" to display the parameter assignment screen.

- Press one of the PAGE select keys (Δ / ∇) to change to the first setting screen of Controller 1 or 2.

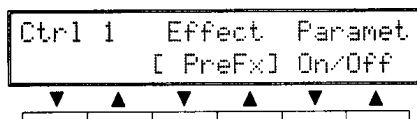

- Press the ∇ or \blacktriangle function key under "Effect" to select the effect type (PreFx, MainFx or PostFx).
- Press the ∇ or \blacktriangle function key under "Parameter" to select the parameter to be controlled.

NOTE: Some parameters cannot be controlled by MIDI control change messages. These parameters are marked with an "★" in the section THE PROGRAMS & PARAMETERS starting on page 20.

- Press one of the PAGE select keys (Δ / ∇) to change to the control range setting screen.

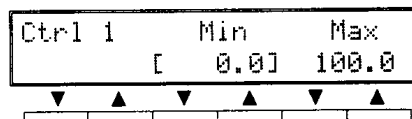

Here you can set the range (0 ~ 100%) within which the parameter can be controlled by control change messages.

Example: The setting range of the L.Thrs parameter of the pre-(post)effect "Comp" is -24 dB ~ +12 dB. By setting Min. to 10% and Max. to 90 % the parameter control range will be -20 dB ~ +9 dB for MIDI parameter control. Please verify this setting by actually listening to the sound.

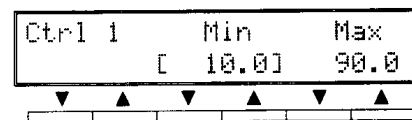

- Press the ∇ or \blacktriangle function key under "Min" ("Max") to set the minimum (maximum) value.
- Repeat steps ④ to ⑧ to assign a parameter to the other controller, if necessary.
- Store the program as described in the section STORING A PROGRAM on page 16.

MIDI BULK OUT (Edit Mode: Page 3)

The SPX990 can transmit bulk data to external MIDI devices. The following bulk data types can be selected:

All Data

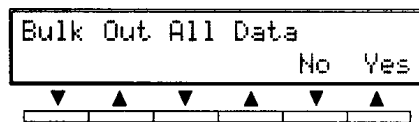

To bulk dump all data (System Data + User's Memory All + PGM Change Tbl + User's Scale).

System Data

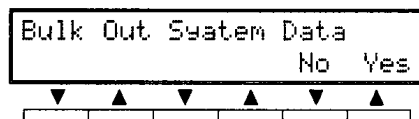

To bulk dump system data (MIDI Controller, Input Mode, Foot Switch, User's Memory Protect settings).

User's Memory Data

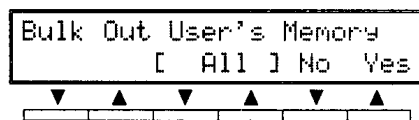

To bulk dump Data (U01 ~ U99, U00, A11) in the User's Memory.

PGM Change Tbl Data

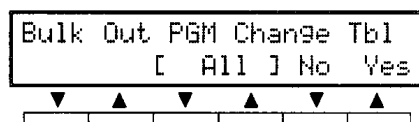

To bulk dump the data in the specified bank (A, B, C, D or A11).

User's Scale Data

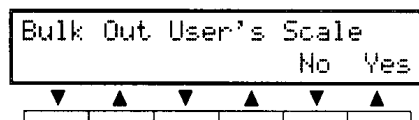

To bulk dump the data of user scales 1 and 2 set for the intelligent pitch change function.

Bulk dump procedure:

- ① Press the EDIT key to enter the edit mode and select Page3 using the PAGE select keys (△ / ▽).

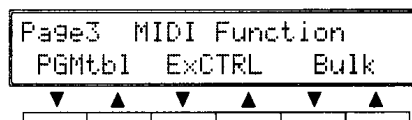

- ② Press the ▼ or ▲ function key under "Bulk" to change to the "Bulk Out" screen.
- ③ Press one of the PAGE select keys (△ / ▽) to change to the bulk dump data select screen shown on the left.
- ④ To bulk dump user's memory data you must specify the memory No.

Press the ▼ or ▲ function key under "[]" to select the memory No. (U01 ~ U99, U00, A11). When "A11" is selected, the SPX990 will bulk dump all data in the user's memory (U01 ~ U99, U00).

NOTE: If bulk data is transmitted to another SPX990, it will replace the data in the corresponding memory locations of the receiving unit.

- ⑤ To bulk dump program change table data you must specify the bank.

Press the ▼ or ▲ function key under "[]" to select the bank (A, B, C, D, A11). When "A11" is selected, the SPX990 will bulk dump the program change table data of all banks.

NOTE: If bank data is transmitted to another SPX990, it will replace the data in the corresponding bank(s) of the receiving unit.

- ⑥ After selecting the data type, press the ▲ function key under "Yes" to start the bulk dump operation.
- ⑦ When the bulk dump is completed, the display will return to the previous screen.

Press the EDIT key to return to Page3 of the edit mode, or the MEMORY key to return to the memory mode.

APPENDIX

ANNEXE

ANHANG

**APPENDIX
ANNEXE
ANHANG**

SPECIFICATIONS

ELECTRICAL CHARACTERISTICS

Freq. Response	20Hz-20kHz±0.5dB
Dynamic Range	Above 100dB (Typical 106dB)
Hum and Noise	Below -82dBm (Typical -88dBm)
Distortion	Below 0.005% at max. level 1kHz

INPUT

Number of Channels	2 (balanced)
Nominal Level	+4/-20dBm (Switchable)
Max. Level	+24dBm (at +4dB switch position)
Impedance	20kΩ

OUTPUT

Number of Channels	2 (balanced)
Nominal Level	+4/-20dBm (Switchable)
Max. Level	+18dBm (at +4dB switch position)
Impedance	150Ω

AD/DA Conversion

A/D Conversion	20-bit linear
D/A Conversion	20-bit linear
Sampling Freq.	44.1kHz

MEMORY

Preset Program	No.1 - 80
User Memory Program	No.1 - 99, 00
Optional Memory Card	No.1 - 99, 00

MIDI CONTROL

Program Change	(Memory Select)
Note On	(Pitch Select)
Control Change	(Parameter Control)
Bulk Dump	(Parameter Settings, Program Change Table, System Setup Data)

FRONT PANEL

Controls	INPUT LEVEL (L, R), DATA ENTRY
Keys	Function Keys x 6, PAGE Select Keys x 2, MEMORY, STORE, EDIT, BYPASS Keys
Display	8-segment LED x 2 (Level Meter) 6-segment LED (Mode Indicator) 7-segment LED (Memory No.) MEMORY, EDIT, BYPASS indicators LCD (24 characters x 2 lines)
Slot	MEMORY CARD

REAR PANEL

Connectors	INPUT L/R (XLR x 2, phone jack x 2) OUTPUT L/R (XLR x 2, phone Jack x 2) MIDI IN, THRU/OUT (DIN 5P x 2) TRIGGER (phone jack x 1) Bypass or INC/DEC (Phone Jack x 1)
Switch	IN/OUT Level Switch (+4dB/-20dB x 2) MIDI THRU/OUT Switch

GENERAL

Power Requirements	US & Canadian Models: 120V, 60Hz British Model: 240V, 50Hz General Model: 230V, 50Hz
--------------------	--

Power Consumption	25W
-------------------	-----

Dimensions (W x H x D)	480 x 46 x 324.4 mm (18-7/8" x 1-13/16" x 12-3/4") (including attachments)
---------------------------	--

Weight	4.6 kg (10 lbs. 2oz)
--------	----------------------

* 0dB=0.775Vr.m.s.

* Specifications and appearance subject to change without notice.

■ OPTION

Memory Card	MCD32 MCD64
-------------	----------------

CARACTERISTIQUES TECHNIQUES

CARACTERISTIQUES ELECTRIQUES

Réponse en fréquence	20 Hz ~ 20 kHz $\pm 0,5$ dB
Plage dynamique	Supérieure à 100 dB (106 dB typique)
Bourdonnement et bruit de fond	
	Inférieur à -82 dBm (-88 dBm typique)
Distorsion	Inférieure à 0,005 % au niveau maxi. 1 kHz

ENTREE

Nombre de canaux	2 (prises jack)
Niveau nominal	+4/-20 dBm (commutable)
Entrée maxi.	+24 dBm (commutable à +4 dB)
Impédance	20 k Ω

SORTIE

Nombre de canaux	2 (prise jack)
Niveau nominal	+4/-20 dBm (commutable)
Sortie maxi.	+18 dBm (commutable à +4 dB)
Impédance	150 Ω

Conversion AN/NA

Conversion A/N	20 bits
Conversion N/A	20 bits
Fréquence d'échantillonnage	44,1 kHz

MEMORY

Programmes prééglés	1 - 80
Programmes utilisateur	1 - 99, 00
Carte de mémoire optionnelle	1 - 99, 00

COMMANDE MIDI

Changement de programme	(Sélection de mémoire)
Note ON	(Sélection de hauteur)
Changement de commande	(Contrôle de paramètre)
Vidage mémoire	(Vidage de paramètres, tableau de changement de programme, données de configuration du système)

PANNEAU AVANT

Réglages	Niveau d'entrée (L, R), DATA ENTRY
Touches	Touches de fonction x 6, touches de sélection de page x 2, MEMORY, STORE, BYPASS
Affichage	Diodes à 8 segments 2 canaux (indicateur de niveau) Diodes à 6 segments (indicateur de mode) Diodes à 7 segments (N° de mémoire) Indicateurs MEMORY, EDIT, BYPASS Ecran LCD 24 caractères x 2 lignes
Fente	Carte de mémoire

PANNEAU ARRIERE

Connecteurs	Entrée L/R (XLR x 2, prise jack x 2) Sortie L/R (XLR x 2, prise jack x 2) MIDI IN, THRU/OUT (DIN 5 broches x 2) TRIGGER (prise jack x 1) BYPASS ou INC/DEC (prise jack x 1)
Commutateur	Commutateur de niveau IN/OUT (+4 dB/-20 dB x 2) Commutateur MIDI THRU/OUT

GENERALITES

Alimentation	U.S.A. et Canada: Secteur 120 V, 60 Hz Royaume-Uni: Secteur 240 V, 50 Hz Modèle général: Secteur 230 V, 50 Hz
--------------	---

Consommation	25 W
--------------	------

Dimensions hors tout (L x H x P)	480 x 46 x 324,4 mm
----------------------------------	---------------------

Poids	4,6 kg (10 livres 2 onces)
-------	----------------------------

* 0 dB = 0,775 Vrms

* Caractéristiques et présentation susceptibles d'être modifiées sans préavis.

■ OPTION

Carte de mémoire	MCD32 MCD64
------------------	----------------

TECHNISCHE DATEN

ELEKTRISCHE WERTE

Frequenzgang	20 Hz - 20 kHz, $\pm 0,5$ dB
Dynamikbereich	Über 100 dB (typisch: 106 dB)
Rauschabstand	Unter -82 dBm (typisch: -88 dBm)
Verzerrungsgrad	Unter 0,005% bei max. Pegel 1 kHz

EINGÄNGE

Anzahl der Kanäle	2 (Klinke)
Nennpegel	+4/-20 dBm (umschaltbar)
Höchsteingang	+24 dBm (umschaltbar bei +4 dB)
Impedanz	20 Ohm

AUSGÄNGE

Anzahl der Kanäle	2 (Klinke)
Nennpegel	+4/-20 dBm (umschaltbar)
Höchstaussgang	+18 dBm (umschaltbar bei +4 dB)
Impedanz	150 Ohm

AD/DA-UMWANDLUNG

A/D-Umwandlung	20 Bit
D/A-Umwandlung	20 Bit
Sampling-Frequenz	44,1 kHz

SPEICHER

Preset-Programme	1 - 80
Anwenderprogramme	1 - 99,00
Speicherkarte (Sonderzubehör)	1 - 99,00

MIDI-STEUERUNG

Pr's Scale Data	(Speicheranwahl)
Note-An	(Transponierungswahl)
Steueränderung	(Parametersteuerung)
Blockabwurf	(Parameterübertragung, Programmwechselfabelle, System-Setup-Daten)

FRONTTAFEL

Regler	INPUT LEVEL (L, R), DATA ENTRY
Tasten	Funktionstasten x 6, "Page"-Wahltasten x 2, MEMORY, STORE, EDIT, BYPASS
Display	2 Kanäle, 8 LED-Segmente (Pegelmesser) 6 LED-Segmente (Modusanzeige) 7 LED-Segmente (Speicher-Nr.) Memory-, Edit-, Bypass-Anzeigen 24 LCD-Zeichen x 2 Zeilen
Steckplatz	Speicherkarte

RÜCKWAND

Buchsen	INPUT L/R (XRL x 2, Klinke x 2) OUTPUT L/R (XRL x 2, Klinke x 2) MIDI IN, THRU/OUT (DIN 5P x 2) TRIGGER (Klinke x 1) BYPASS oder INC/DEC (Klinke x 1) IN/OUT-Pegelschalter (+4 dB/-20 dB x 2) MIDI THRU/OUT
Schalter	

ALLGEMEINE DATEN

Stromversorgung	US- und Kanada-Modell: 120 V, 60 Hz Großbritannien-Modell: 240 V, 50 Hz Allgemeines Modell: 230 V, 50 Hz
Leistungsaufnahme	25 W
Abmessungen	480 (B) x 46 (H) x 324,4 (T) mm (einschließlich Anbauteile)
Gewicht	4,6 kg

* 0 dB = 0,775 Vr.m.s.

* Änderung der technischen Daten ohne Vorankündigung vorbehalten.

■ SONDERZUBEHÖR

Speicherkarte	MCD32 MCD64
---------------	----------------

■ BLOCK DIAGRAM / SCHEMA DE PRINCIPE / BLOCKDIAGRAMM

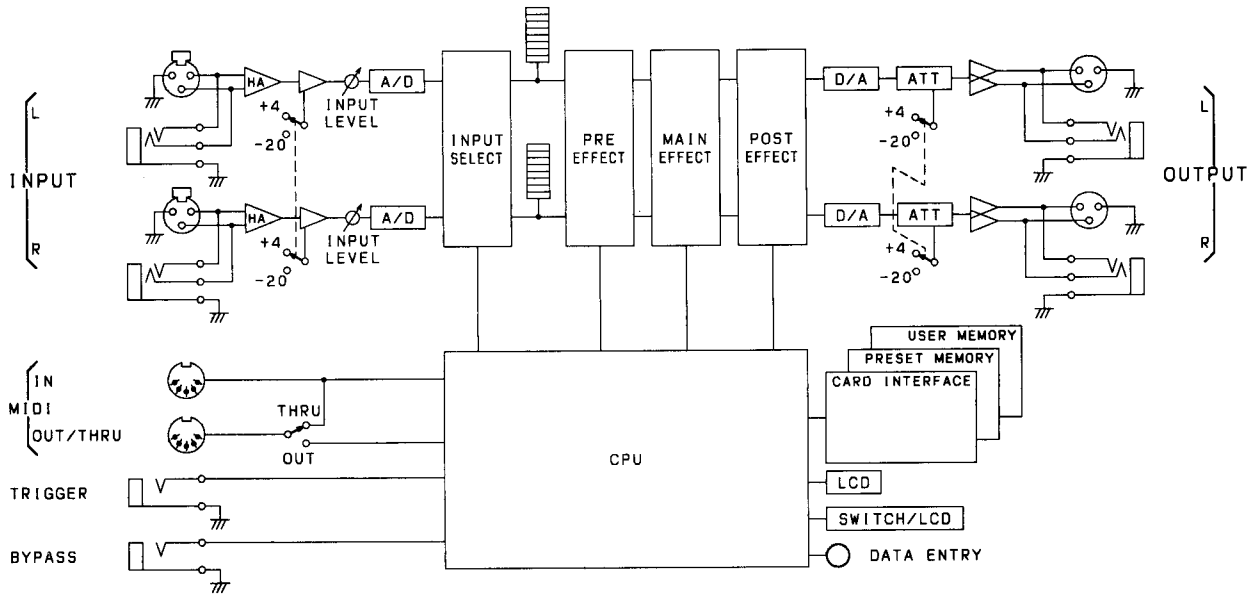

■ DIMENSIONS / ABMESSUNGEN

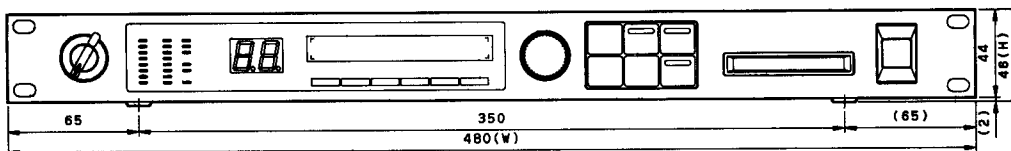
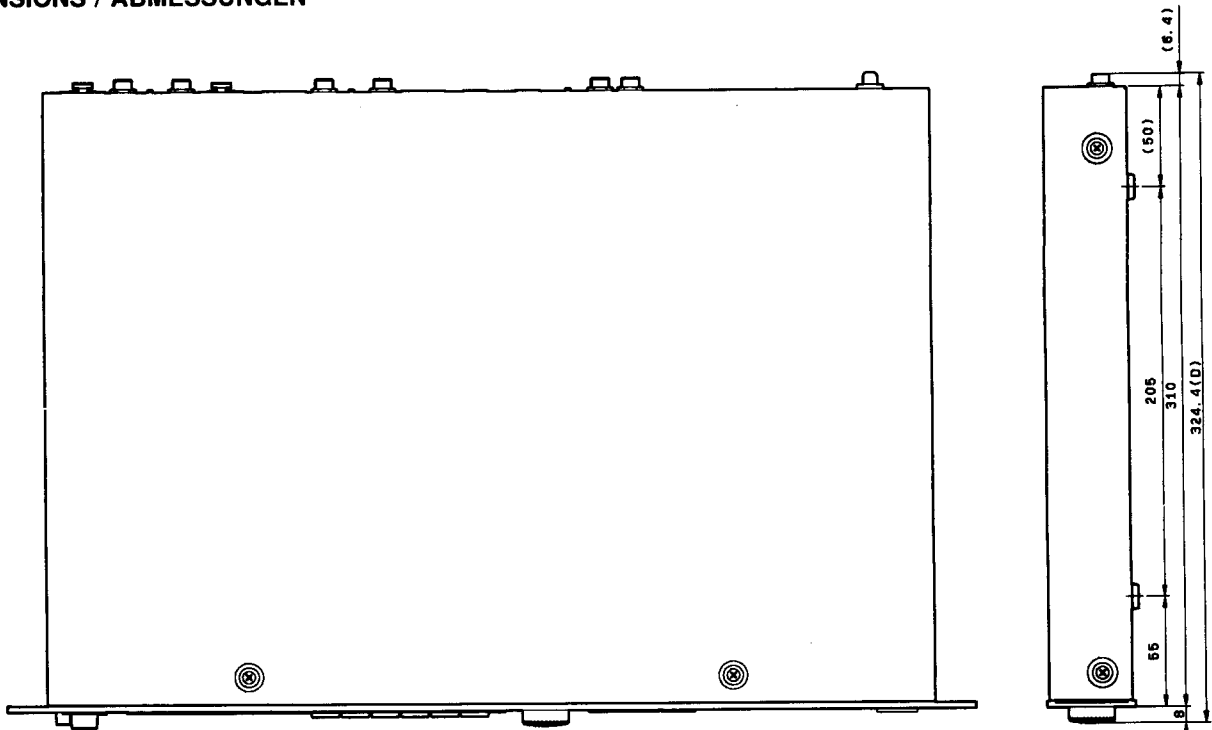

(unit: mm)
 (unité: mm)
 (Einheit: mm)

MIDI DATA FORMAT

1. Transmission Conditions

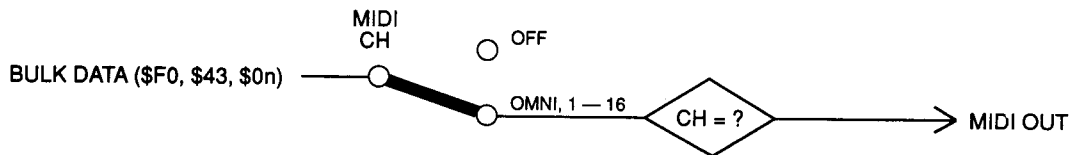

2. Transmission Data

2-1 System Information

1) System Exclusive Messages

① Memory Bulk Data

When a MEMORY BULK OUT operation is performed or when a MEMORY BULK DUMP REQUEST message is received by the SPX990, the data is transmitted on the MIDI channel specified for the currently selected BANK. Data is transmitted from the User memory U01 to U00 in the format below if the memory number is set at "All".

STATUS	11110000 (F0H)
ID No.	01000011 (43H)
SUB STATUS	0000nnnn (0nH) n= 0 (channel number1) - 15 (channel number16)
FORMAT No.	01111110 (7EH)
BYTE COUNT	00000010 (02H)
BYTE COUNT	00110100 (34H)
HEADER	01001100 (4CH) "L" 01001101 (4DH) "M" 00100000 (20H) SPACE 00100000 (20H) SPACE 00111000 (38H) "8" 01000001 (41H) "A" 00110010 (32H) "2" 00110001 (31H) "1"
DATA NAME	01001101 (4DH) "M"
MEMORY	0mmmmmmm m= 1 (User Memory No.U01) - 100 (User Memory No.U00)
DATA	0ddddddd <input type="text"/> 298 BYTE 0ddddddd <input type="text"/>
CHECK SUM	0eeeeee
EOX	11110111 (F7H)

② Bank Program Change Table Bulk Data

When a BANK PROGRAM CHANGE TABLE BULK OUT operation is performed or when a BANK PROGRAM CHANGE TABLE BULK DUMP REQUEST message is received by the SPX990, data is transmitted on the MIDI channel specified for the currently selected BANK. Data is transmitted from Bank A to D in the format below if the bank number is set at "All".

STATUS	11110000 (F0H)
ID No.	01000011 (43H)
SUB STATUS	0000nnnn (0nH) n= 0 (channel number1) - 15 (channel number16)
FORMAT No.	01111110 (7EH)
BYTE COUNT	00000010 (02H)
BYTE COUNT	00000101 (0AH)
HEADER	01001100 (4CH) "L" 01001101 (4DH) "M" 00100000 (20H) SPACE 00100000 (20H) SPACE 00111000 (38H) "8" 01000001 (41H) "A" 00110010 (32H) "2" 00110001 (31H) "1"
DATA NAME	01010100 (54H) "T"
BANK No.	0zzzzzzz z=BANK 1-4 (1=A, 2=B, 3=C, 4=D)
DATA	0ddddddd <input type="text"/> 256 BYTE 0ddddddd <input type="text"/>
CHECK SUM	0eeeeee
EOX	11110111 (F7H)

③ System Setup Bulk Data

When a SYSTEM SETUP BULK OUT operation is performed or when a SYSTEM SETUP DATA DUMP REQUEST message is received by the SPX990, data is transmitted on the MIDI channel specified for the currently selected BANK.

```

STATUS          11110000 (F0H)
ID No.          01000011 (43H)
SUB STATUS      0000nnnn (0nH)  n= 0 (Channel No.1) -
                               15 (Channel No.16)

FORMAT No.      01111110 (7EH)
BYTE COUNT      00000000 (00H)
BYTE COUNT      00011110 (1EH)
HEADER          01001100 (4CH) "L"
                01001101 (4DH) "M"
                00100000 (20H) SPACE
                00100000 (20H) SPACE
                00111000 (38H) "8"
                01000001 (41H) "A"
                00110010 (32H) "2"
                00110001 (31H) "1"
DATA NAME       01010011 (53H) "S"
                00100000 (20H) SPACE
SOFT VERSION #  0vvvvvvv      v = 1
                0rrrrrrr      r = 0

DATA           0ddddddd  18 Byte
                0ddddddd 

CHECK SUM      0eeeeeee
EOX           11110111 (F7H)
    
```

④ User Scale Bulk Data

When a USER SCALE BULK OUT operation is performed or when a USER SCALE DATA DUMP REQUEST message is received by the SPX990, data is transmitted on the MIDI channel specified for the currently selected BANK. Data is transmitted in User-Scale 1,2 in the format below.

```

STATUS          11110000 (F0H)
ID No.          01000011 (43H)
SUB STATUS      0000nnnn (0nH)  n= 0 (Channel No.1) -
                               15 (Channel No.16)

FORMAT No.      01111110 (7EH)
BYTE COUNT      00000011 (03H)
BYTE COUNT      00111011 (3BH)
HEADER          01001100 (4CH) "L"
                01001101 (4DH) "M"
                00100000 (20H) SPACE
                00100000 (20H) SPACE
                00111000 (38H) "8"
                01000001 (41H) "A"
                00110010 (32H) "2"
                00110001 (31H) "1"
DATA NAME       01001001 (49H) "I"
                00100000 (20H) SPACE
DATA           0ddddddd TUNE
                0ddddddd  72 Byte Mono Pitch
                               User Scale 1
                0ddddddd  72 Byte Mono Pitch
                               User Scale 2
                0ddddddd  72 Byte Dual Pitch
                               User Scale 1
                0ddddddd  72 Byte Dual Pitch
                               User Scale 2
                0ddddddd  72 Byte Triple Pitch
                               User Scale 1
                0ddddddd  72 Byte Triple Pitch
                               User Scale 2

CHECK SUM      0eeeeeee
EOX           11110111 (F7H)
    
```

⑤ All Bulk Data

When an ALL BULK OUT operation is performed or when a ALL BULK DUMP REQUEST message is received by the SPX990, data is transmitted on the MIDI channel specified for the currently selected BANK.

All user program data from U01 to U00, all bank program change table A through D and system setup data will be transmitted in this order as follows:

- ① Program of User Memory No. U01 to U00
- ② Program Change Table Bank A through D
- ③ System Setup Data
- ④ User-Scale 1,2 Data

3. Reception Conditions

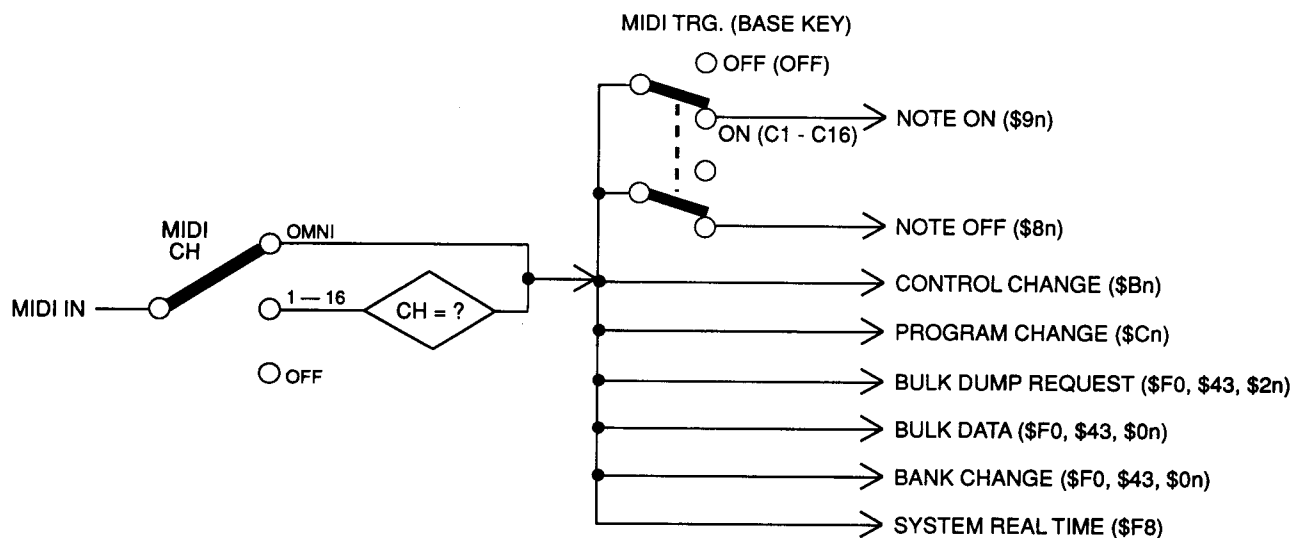

4. Reception Data

4-1 Channel Information

1) Channel Voice Messages

① Note On

Received on the channel specified for the selected bank. When the MidiTrg parameter is set at ON, the main effects of "Reverb", "FiltRev", "EchRoom" and "TrigPan" are triggered. Main effect of MONO PITCH, DUAL PITCH, TRIPLE PITCH and STEREO PITCH programs are received as messages to control pitch variation. The velocity value is ignored here. Data cannot be received when the base key parameter is set at OFF or when the Intelligent Select is at ON.

STATUS	1001nnnn (9nH)	n= 0 (Channel No.1) - 15 (Channel No.16)
NOTE No.	0kkkkkkk	k=0 (C-2) - 127 (G8)
VELOCITY	0vvvvvvv	v=0-127

② Note Off

This message appears during main effect "Freeze" when playback is done and it affects the SPX990 only when the equipment signalling the end NOTE ON message is connected.

STATUS	1000nnnn (8nH)	n= 0 (Channel No.1) - 15 (Channel No.16)
NOTE No.	0kkkkkkk	k=0 (C-2) -127 (G8)
VELOCITY	0vvvvvvv	v=0 - 127

③ Control Change

Received on the channel specified for the selected bank. When a message is received, the value of the assigned effect parameter is changed according to the control value.

STATUS	1011nnnn (BnH)	n= 0 (Channel No.1) - 15 (Channel No.16)
CONTROL NO.	0ccccccc	c=1 - 95
CONTROL VALUE	0vvvvvvv	v=0 - 127

④ Program Change

Received on the MIDI channel specified for the currently selected bank. When a message is received, the corresponding program is called from the program change table of the selected bank.

STATUS	1100nnnn (CnH)	n= 0 (Channel No.1) - 15 (Channel No.16)
PROGRAM NO.	0ppppppp	p=0 - 127

4-2 System Information

1) System Exclusive Messages

① Memory Bulk Dump Request

Received on the MIDI channel specified for the currently selected bank.

When received, the data corresponding to the specified memory program is transmitted.

STATUS	11110000 (F0H)
ID No.	01000011 (43H)
SUB STATUS	0010nnnn (2nH) n= 0 (channel number1) - 15 (channel number16)
FORMAT No.	01111110 (7EH) 01001100 (4CH) "L" 01001101 (4DH) "M" 00100000 (20H) SPACE 00100000 (20H) SPACE 00111000 (38H) "8" 01000001 (41H) "A" 00110010 (32H) "2" 00110001 (31H) "1"
DATA NAME	01001101 (4DH) "M"
MEMORY	0mmmmmm m= 1 (User Memory No.U01) - 100 (User Memory No.U00)
EOX	11110111 (F7H)

② Program Change Table Bulk Dump Request

Received on the MIDI channel specified for the currently selected bank.

When received, the data corresponding to the program change table of the specified bank is transmitted.

STATUS	11110000 (F0H)
ID No.	01000011 (43H)
SUB STATUS	0010nnnn (2nH) n= 0 (channel number1) - 15 (channel number16)
FORMAT No.	01111110 (7EH) 01001100 (4CH) "L" 01001101 (4DH) "M" 00100000 (20H) SPACE 00100000 (20H) SPACE 00111000 (38H) "8" 01000001 (41H) "A" 00110010 (32H) "2" 00110001 (31H) "1"
DATA NAME	01010100 (54H) "T"
BANK No.	0zzzzzzz z=BANK 1-4 (1=A, 2=B, 3=C, 4=D)
EOX	11110111 (F7H)

③ System Setup Data Bulk Dump Request

Received on the MIDI channel specified for the currently specified bank.

When received, the data corresponding to the system setup data of the specified bank is transmitted.

STATUS	11110000 (F0H)
ID No.	01000011 (43H)
SUB STATUS	0010nnnn (2nH) n= 0 (channel number1) - 15 (channel number16)
FORMAT No.	01111110 (7EH) 01001100 (4CH) "L" 01001101 (4DH) "M" 00100000 (20H) SPACE 00100000 (20H) SPACE 00111000 (38H) "8" 01000001 (41H) "A" 00110010 (32H) "2" 00110001 (31H) "1"
DATA NAME	01010011 (53H) "S"
EOX	11110111 (F7H)

④ User Scale Data Bulk Dump Request

Received on the MIDI channel specified for the currently specified bank.

When received, the data corresponding to the User Scale Data of the specified bank is transmitted.

STATUS	11110000 (F0H)
ID No.	01000011 (43H)
SUB STATUS	0010nnnn (2nH) n= 0 (channel number1) - 15 (channel number16)
FORMAT No.	01111110 (7EH) 01001100 (4CH) "L" 01001101 (4DH) "M" 00100000 (20H) SPACE 00100000 (20H) SPACE 00111000 (38H) "8" 01000001 (41H) "A" 00110010 (32H) "2" 00110001 (31H) "1"
DATA NAME	01001001 (49H) "I"
EOX	11110111 (F7H)

2) System Real Time Message

When received on the MIDI channel, the main effects, "TmpEch1", "TmpEch2", "TmpEch4" are triggered. The tempo parameter is set automatically by timing clock.

TIMING CLOCK 11111000 (F8H)

⑤ Bank Change Request

Received on the MIDI channel specified for the currently selected bank.

When received, the specified bank is called up.

STATUS	11110000 (F0H)	
ID No.	01000011 (43H)	
SUB STATUS	0000nnnn (0nH)	n= 0 (Channel No.1) - 15 (Channel No.16)
FORMAT No.	01111100 (7CH)	Condition setup
BYTE COUNT	00000000 (00H)	
BYTE COUNT	00001101 (0DH)	
	01001100 (4CH)	"L"
	01001101 (4DH)	"M"
	00100000 (20H)	SPACE
	00100000 (20H)	SPACE
	00111000 (38H)	"8"
	01000001 (41H)	"A"
	00110010 (32H)	"2"
	00110001 (31H)	"1"
DATA NAME	01010101 (55H)	"U"
	00100000 (20H)	SPACE
VERSION #	0vvvvvvv	v = 1
VERSION #	0rrrrrrr	r = 0
DATA	0zzzzzzz	z = bank 1 - 4 (1=A, 2=B, 3=C, 4=D)
CHECK SUM	0eeeeeee	
EOX	11110111 (F7H)	

⑥ Memory Bulk Data

The data format is the same as "Memory Bulk Data" for transmission.

⑦ Bank Program Change Table Bulk Data

The data format is the same as "Bank Program Change Table Bulk Data" for transmission.

⑧ User Scale Bulk Data

The data format is the same as "User Scale Bulk Data" for transmission.

⑨ System Setup Bulk Data

The data format is the same as "System Setup Bulk Data" for transmission.

When received from the MIDI Data Filer, a computer or other sources, the time interval between data exchanges. F7 to F0 and other units must be set to 180msec or longer.

Function ...	Transmitted	Recognized	Remarks
Basic Default Channel Changed	x x	1-16, off 1-16, off	memorized
Mode Default Default Altered	x x *****	OMNIoff/OMNIon x x	memorized
Note Number : True voice	x *****	0-127 x	
Velocity Note ON Note OFF	x x	x x	
After Key's Touch Ch's	x x	x x	
Pitch Bender	x	x	
Control Change 1 - 95	x	o	
Program Change : True #	x *****	o 0 - 127	*1
System Exclusive	o	o	Bulk Dump
System : Song Pos : Song Sel Common : Tune	x x x	x x x	
System :Clock Real Time :Commands	x x	o x	
Aux :Local ON/OFF :All Notes OFF Mes- :Active Sense sages:Reset	x x x x	x x x x	

Notes: *1 = For program 1 - 128, memory number of SPX990 is selected.

SFX990 USER PROGRAMMING TABLE

Date : / / _____

Programmer : _____

Memory No.	Program Name	EFFECT		
		PreFx	MainFx	.PostFx
1				
2				
3				
4				
5				
6				
7				
8				
9				
10				
11				
12				
13				
14				
15				
16				
17				
18				
19				
20				
21				
22				
23				
24				
25				
26				
27				
28				
29				
30				
31				
32				
33				
34				
35				
36				
37				
38				
39				
40				

Memory No.	Program Name	EFFECT		
		PreFx	MainFx	PostFx
41				
42				
43				
44				
45				
46				
47				
48				
49				
50				
51				
52				
53				
54				
55				
56				
57				
58				
59				
60				
61				
62				
63				
64				
65				
66				
67				
68				
69				
70				
71				
72				
73				
74				
75				
76				
77				
78				
79				
80				

SPX990 USER PROGRAMMING TABLE

Memory No. : _____ Date : / /

Program Name : _____ Programmer : _____

● **PreFx**

Parameter															
On/Off	Type	StLink	1	2	3	4	5	6	7	8	9	10	11	12	13
ON	P.EQ	ON													
	Comp.		14	15	16	17	18	19	20	21	22	23	24	25	26
OFF	Dist.	OFF													

● **MainFx**

Parameter															
On/Off	Balan1	Balan2	1	2	3	4	5	6	7	8	9	10	11	12	13
ON															
OFF			14	15	16	17	18	19	20	21	22	23	24	25	26

● **PostFx**

Parameter															
On/Off	Type	StLink	1	2	3	4	5	6	7	8	9	10	11	12	13
ON	P.EQ	ON													
	Comp.		14	15	16	17	18	19	20	21	22	23	24	25	26
OFF	AuraIX	OFF													

Date : / /

Programmer : _____

MIDI PGM	BANK / ch			
	A/	B/	C/	D/
1				
2				
3				
4				
5				
6				
7				
8				
9				
10				
11				
12				
13				
14				
15				
16				
17				
18				
19				
20				
21				
22				
23				
24				
25				
26				
27				
28				
29				
30				
31				
32				
33				
34				
35				
36				
37				
38				
39				
40				
41				
42				
43				

MIDI PGM	BANK / ch			
	A/	B/	C/	D/
44				
45				
46				
47				
48				
49				
50				
51				
52				
53				
54				
55				
56				
57				
58				
59				
60				
61				
62				
63				
64				
65				
66				
67				
68				
69				
70				
71				
72				
73				
74				
75				
76				
77				
78				
79				
80				
81				
82				
83				
84				
85				
86				

MIDI PGM	BANK / ch			
	A/	B/	C/	D/
87				
88				
89				
90				
91				
92				
93				
94				
95				
96				
97				
98				
99				
100				
101				
102				
103				
104				
105				
106				
107				
108				
109				
110				
111				
112				
113				
114				
115				
116				
117				
118				
119				
120				
121				
122				
123				
124				
125				
126				
127				
128				

SERVICE

This product is supported by YAMAHA's worldwide network of factory trained and qualified dealer service personnel. In the event of a problem, contact your nearest YAMAHA dealer.

ENTRETIEN

L'entretien de cet appareil est assuré par le réseau mondial YAMAHA de personnel d'entretien qualifié et formé en usine des concessionnaires. En cas de problème, prendre contact avec le concessionnaire YAMAHA le plus proche.

KUNDENDIENST

Für dieses Gerät steht das weltweite YAMAHA Kundendienstnetz mit qualifiziertem, werksgeschultem Personal zur Verfügung. Bei Störungen und Problemen wenden Sie sich bitte an Ihren YAMAHA-Händler.

YAMAHA